



THE ULTIMATE CHOICE

ARTERY FORCEPS

Artery Forceps
Arterienklemmen
Pinzas hemostáticas
ЗАЖИМЫ АРТЕРИАЛЬНЫЕ
动脉钳

Bulldog Clamps, Setting Forceps
 Bulldogklemmen, Alegepinzetten
 Clamps bulldog, pinzas para poner
 Зажимы типа бульдог, Зажимы специальные для установки клипс
 斗牛犬夹, 设置镊

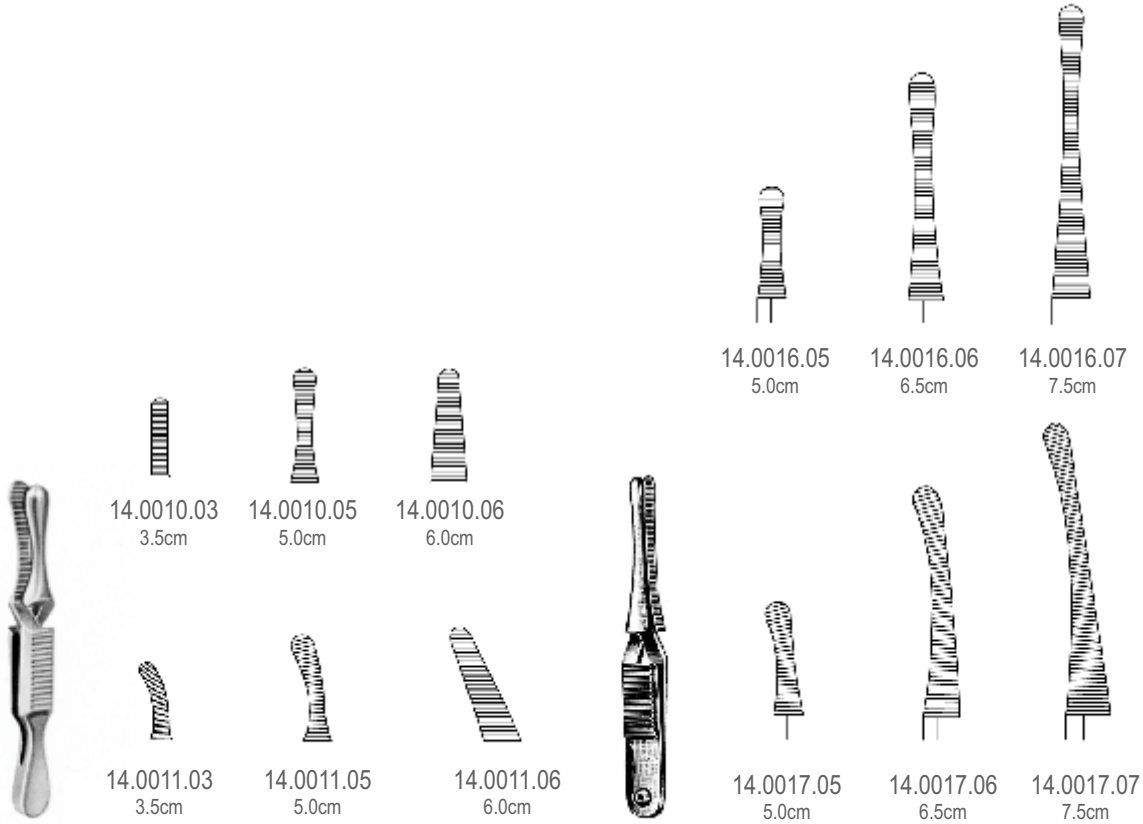

DIEFFENBACH

JOHNS-HOPKINS

ARTERY FORCEPS

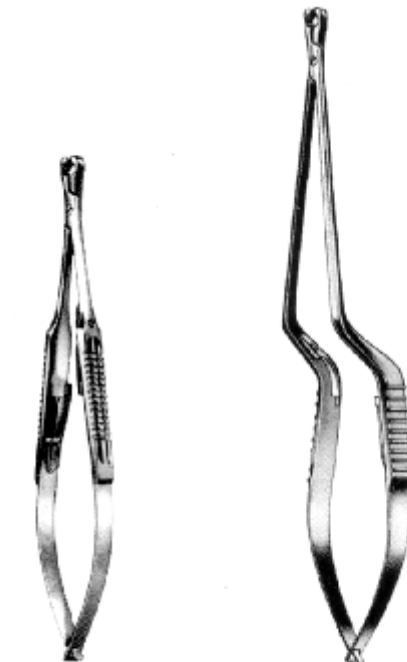
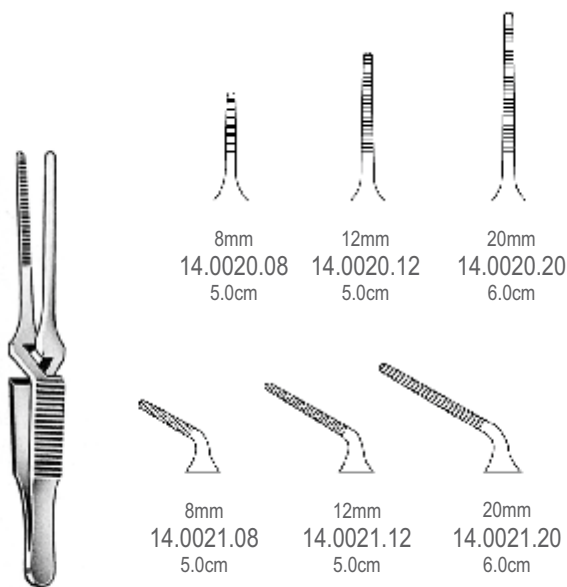

14.0026.14
14.0cm

14.0028.18
18.0cm

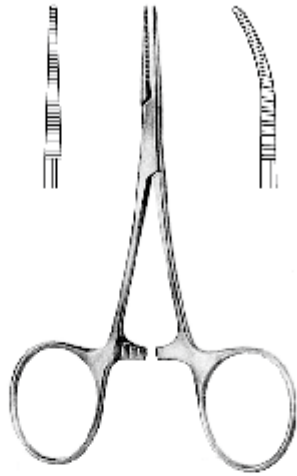

HARTMANN
14.0030.10 10.0cm 14.0031.10

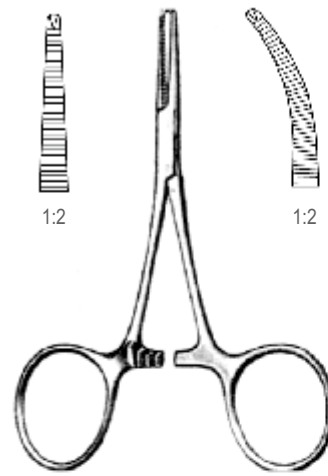

HARTMANN
14.0032.10 10.0cm 14.0033.10

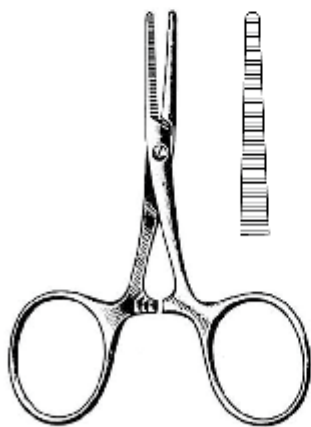

CARREL
14.0040.08 8.5cm

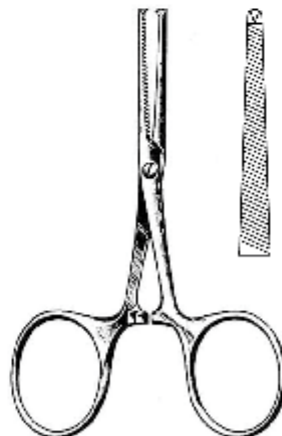

TERRIER
14.0044.08 8.5cm

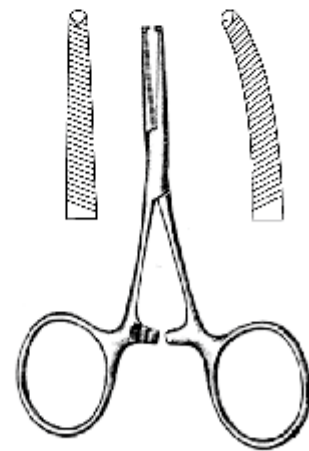

TERRIER
14.0048.09 9.0cm 14.0049.09

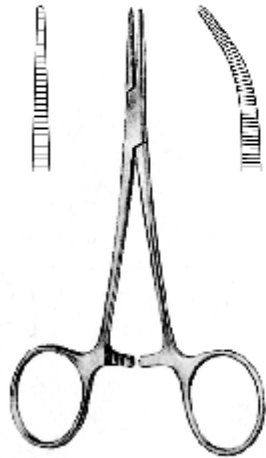

HALSTED-MOSQUITO
 14.0060.12 12.5cm 14.0061.12
 14.0060.14 14.0cm 14.0061.14

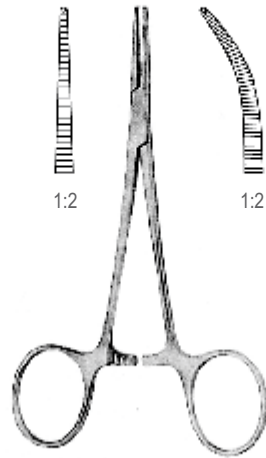

HALSTED-MOSQUITO
 14.0062.12 12.5cm 14.0063.12
 14.0062.14 14.0cm 14.0063.14

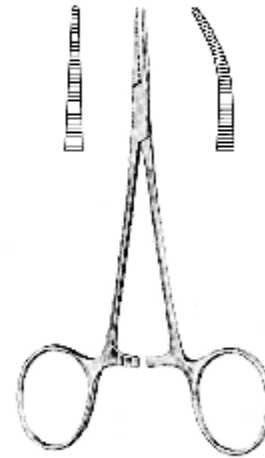

MICRO-MOSQUITO
 14.0070.10 10.0cm 14.0071.10
 14.0070.12 12.0cm 14.0071.12
 14.0070.14 14.0cm 14.0071.14

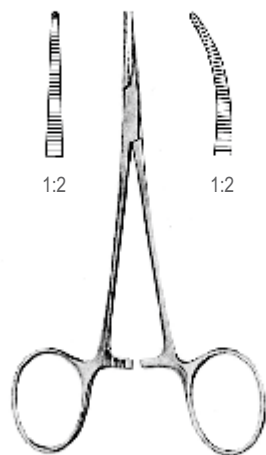

MICRO-MOSQUITO
 14.0072.10 10.0cm 14.0073.10
 14.0072.12 12.0cm 14.0073.12
 14.0072.14 14.0cm 14.0073.14

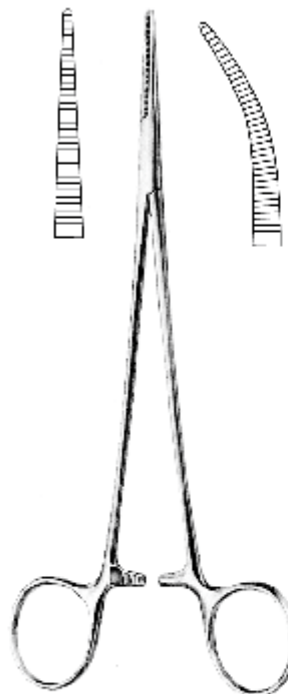

HALSTED-MOSQUITO
 14.0080.16 16.0cm 14.0081.16
 14.0080.18 18.0cm 14.0081.18
 14.0080.21 21.0cm 14.0081.21

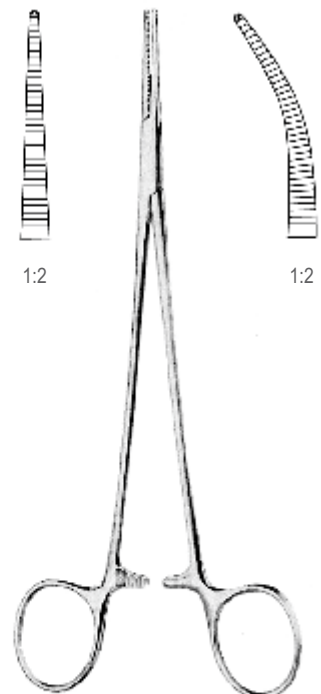

HALSTED-MOSQUITO
 14.0082.16 16.0cm 14.0083.16
 14.0082.18 18.0cm 14.0083.18
 14.0082.21 21.0cm 14.0083.21

ARTERY FORCEPS

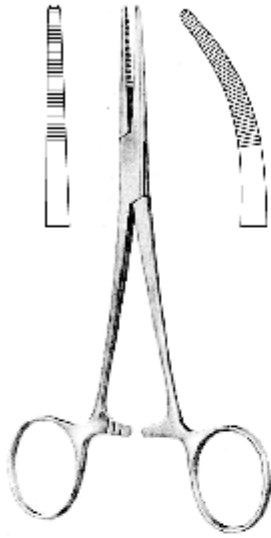

KELLY
14.0090.14 14.0cm 14.0091.14

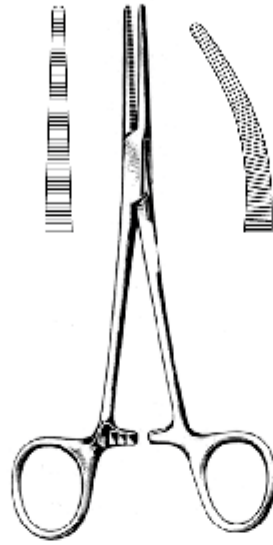

CRILE
14.0094.14 14.0cm 14.0095.14

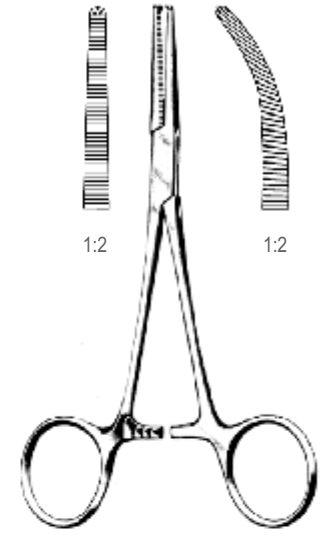

CRILE
14.0096.14 14.0cm 14.0097.14

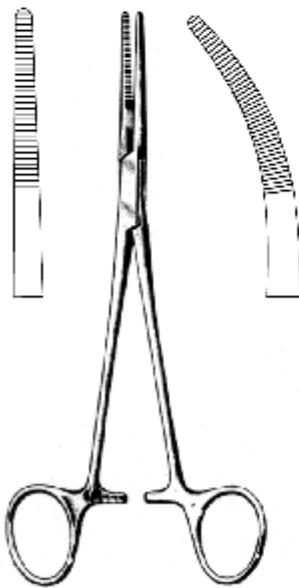

RANKIN-KELLY
14.0100.16 16.0cm 14.0101.16

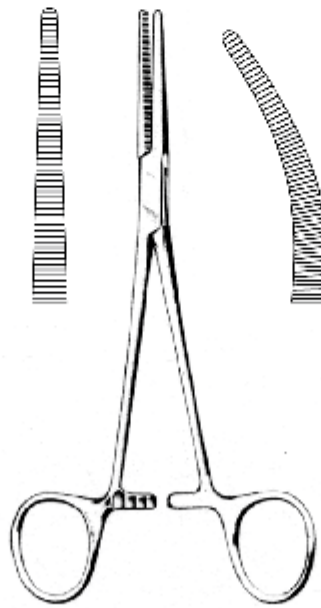

RANKIN-CRILE
14.0104.16 16.0cm 14.0105.16

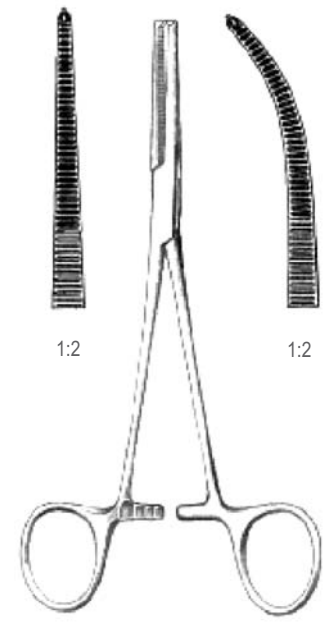

CRILE-RANKIN
14.0106.16 16.0cm 14.0107.16

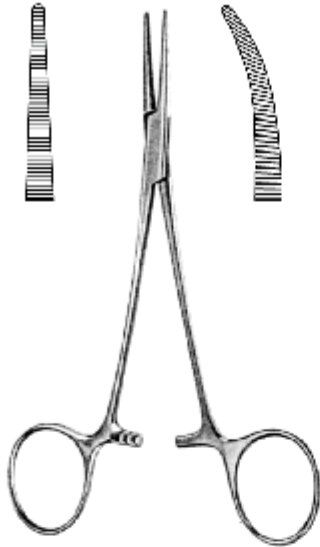

CRILE-DELICATE
 14.0110.14 14.0cm 14.0111.14

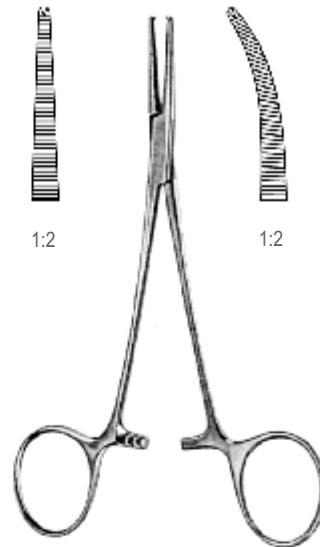

CRILE-DELICATE
 14.0116.14 14.0cm 14.0117.14

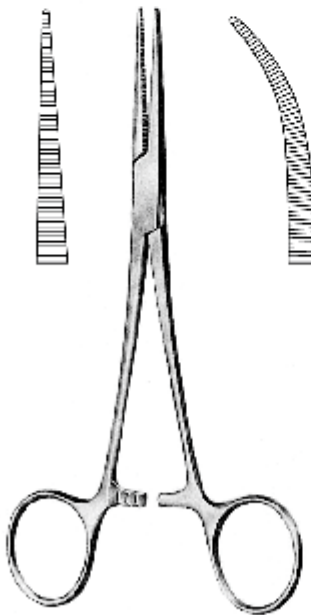

COLLER-CRILE
 14.0120.14 14.0cm 14.0121.14
 14.0120.16 16.0cm 14.0121.16

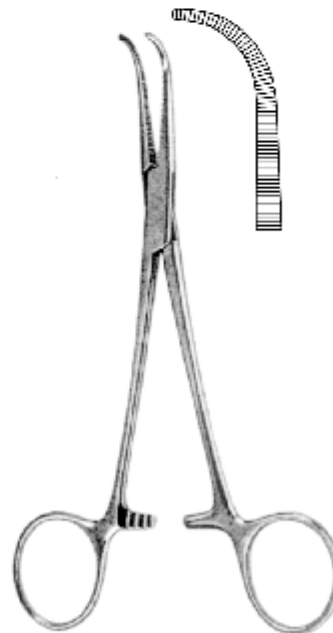

COLLER-CRILE
 14.0126.16 16.0cm

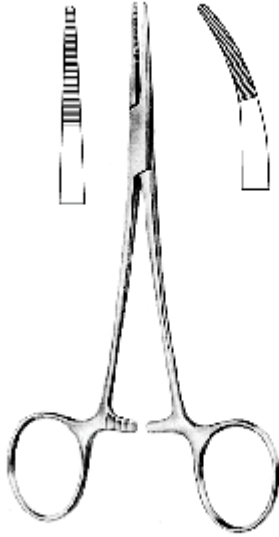

PROVIDENCE-HOSPITAL
14.0130.14 14.0cm 14.0131.14

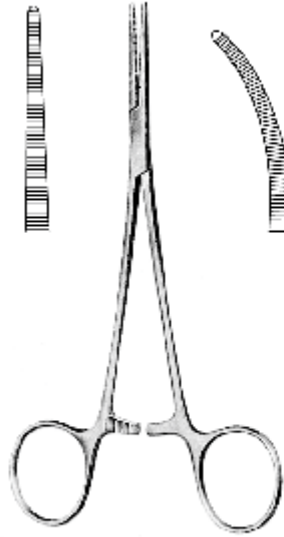

LERICHE
14.0136.15 15.0cm 14.0137.15

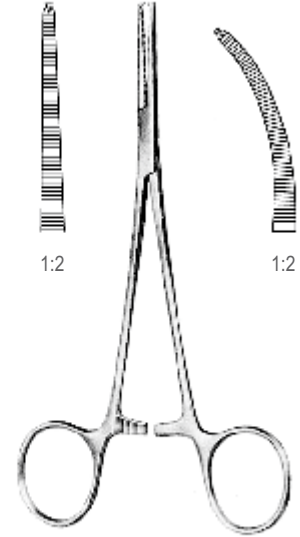

LERICHE
14.0138.15 15.0cm 14.0139.15

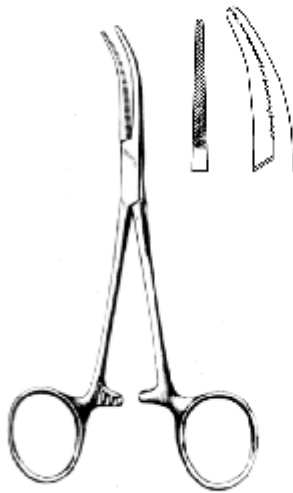

BABY-DANDY
14.0140.12 12.0cm

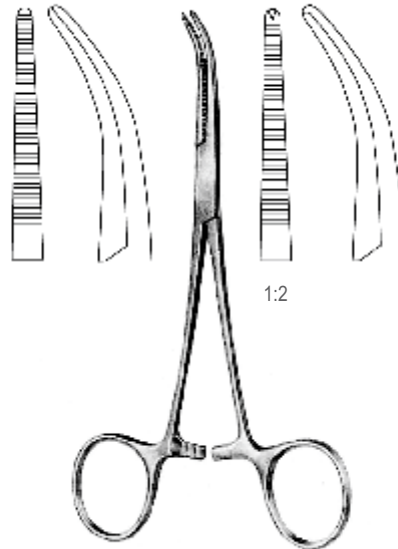

DANDY
14.0142.14 14.0cm 14.0144.14

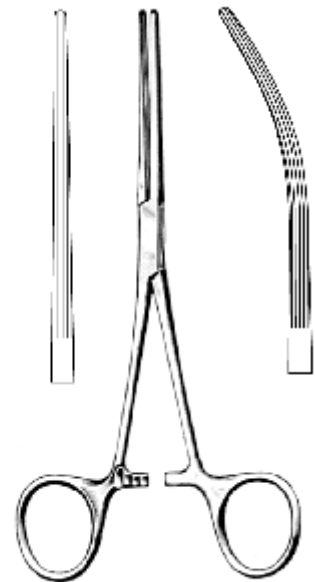

BAINBRIDGE
14.0150.15 15.0cm 14.0151.15
14.0150.18 18.5cm 14.0151.18

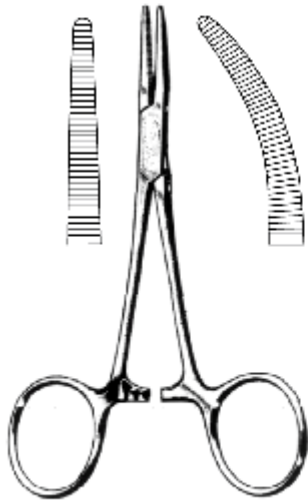

JONES

14.0156.12 12.5cm 14.0157.12
 14.0156.15 15.0cm 14.0157.15

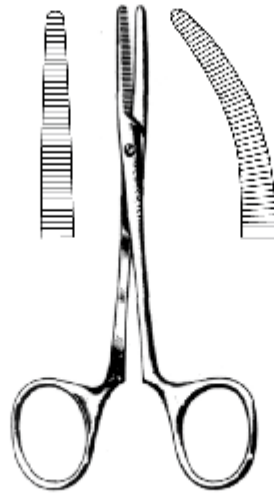

SPENCER-WELLS

14.0160.12 12.5cm 14.0161.12
 14.0160.15 15.0cm 14.0161.15
 14.0160.18 18.0cm 14.0161.18
 14.0160.20 20.0cm 14.0161.20
 14.0160.23 23.0cm 14.0161.23

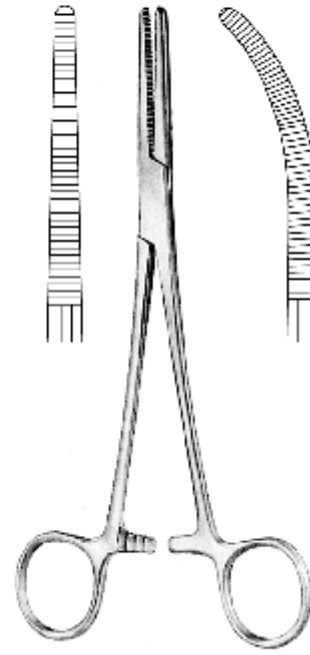

SPENCER-WELLS

14.0162.13 13.0cm 14.0163.13
 14.0162.14 14.0cm 14.0163.14
 14.0162.15 15.0cm 14.0163.15
 14.0162.18 18.0cm 14.0163.18
 14.0162.20 20.0cm 14.0163.20
 14.0162.23 23.0cm 14.0163.23

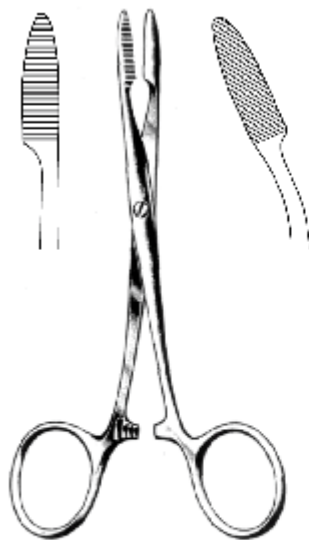

PEAN

14.0170.12 12.5cm 14.0171.12
 14.0170.14 14.0cm 14.0171.14
 14.0170.16 16.0cm 14.0171.16

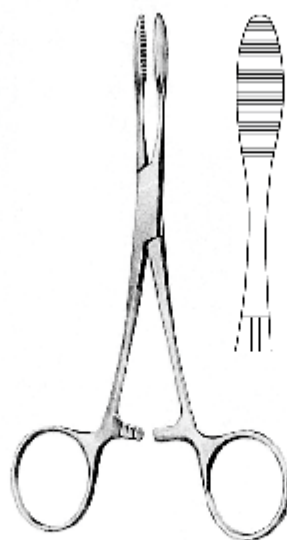

PEAN

14.0172.12 12.5cm
 14.0172.14 14.0cm
 14.0172.16 16.0cm

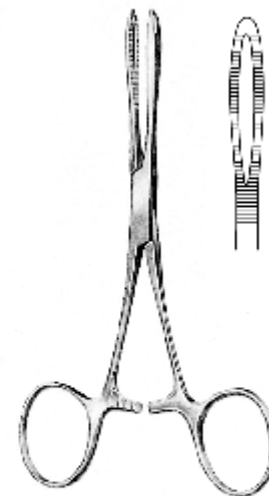

KROENLIEN

14.0176.14 14.0cm 14.0178.14

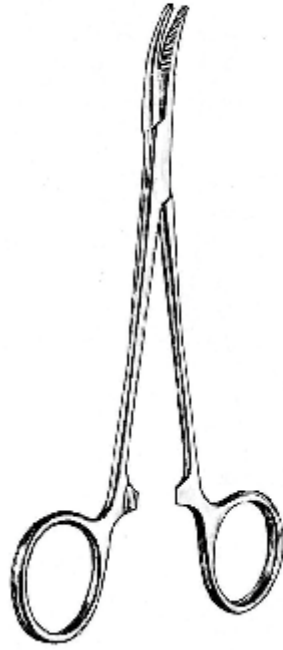

CAIRNS
14.0180.14 14.5cm 14.0181.14

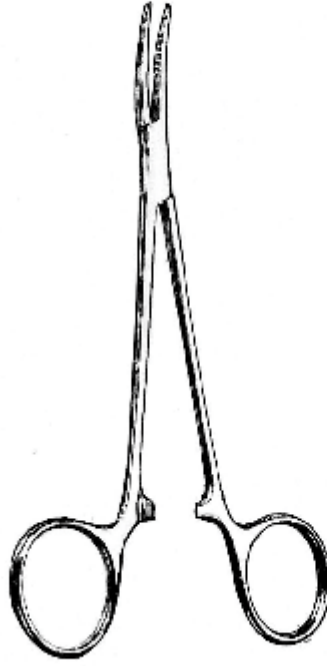

CUSHING
14.0186.14 14.0cm 14.0187.14

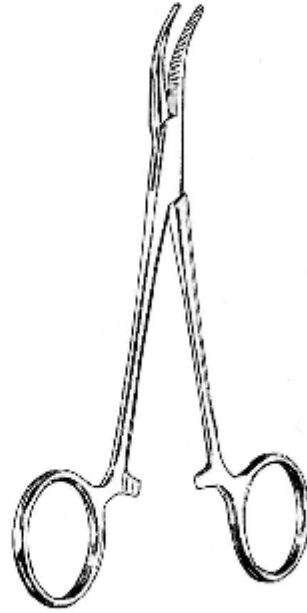

KILNER
14.0190.14 14.0cm 14.0191.14

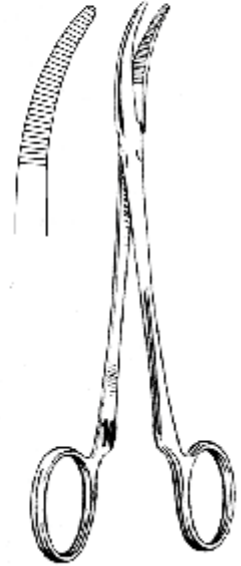

KELLY
14.0196.12 12.5cm

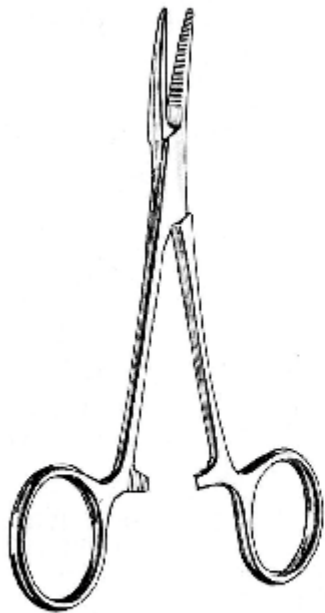

DUNHILL
14.0200.12 12.5cm 14.0201.12

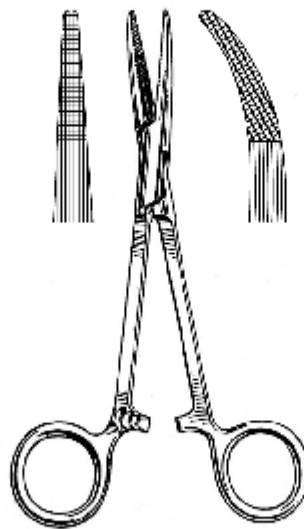

GREY-TURNER
14.0206.15 15.0cm 14.0207.15

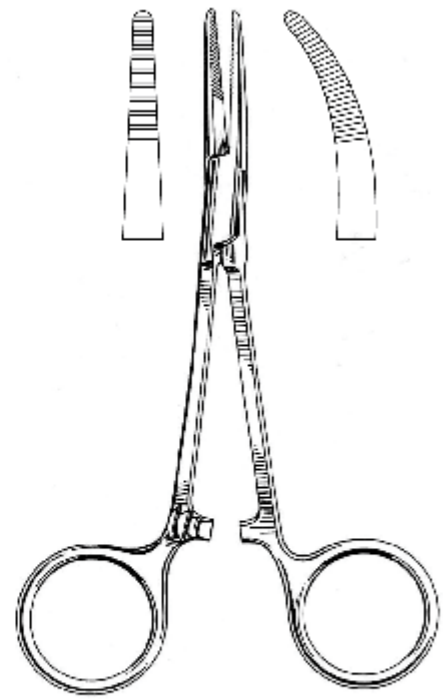

MOYNIHAN
14.0210.14 14.5cm 14.0211.14

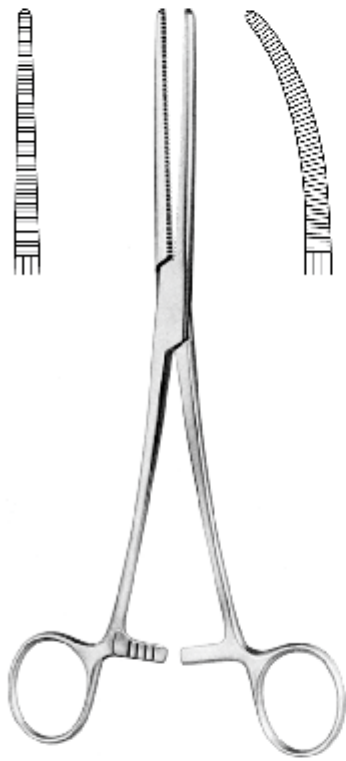

PEAN (ROCHESTER)

14.0220.13	13.0cm	14.0221.13
14.0220.14	14.0cm	14.0221.14
14.0220.16	16.0cm	14.0221.16
14.0220.18	18.0cm	14.0221.18
14.0220.20	20.0cm	14.0221.20
14.0220.22	22.0cm	14.0221.22
14.0220.24	24.0cm	14.0221.24
14.0220.26	26.0cm	14.0221.26
14.0220.28	28.0cm	14.0221.28
14.0220.30	30.0cm	14.0221.30

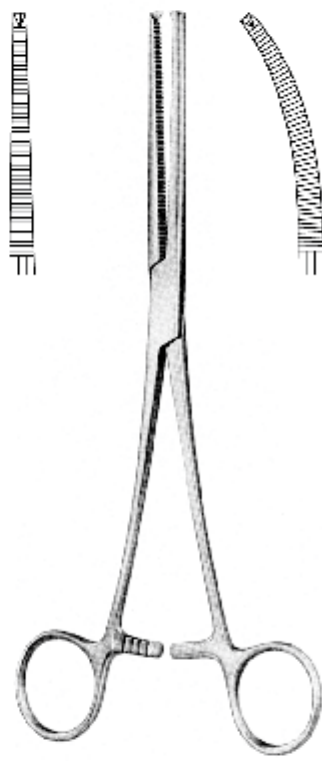

KOCHER (OCHSNER)

14.0226.13	13.0cm	14.0227.13
14.0226.14	14.0cm	14.0227.14
14.0226.16	16.0cm	14.0227.16
14.0226.18	18.0cm	14.0227.18
14.0226.20	20.0cm	14.0227.20
14.0226.22	22.0cm	14.0227.22
14.0226.24	24.0cm	14.0227.24
14.0226.26	26.0cm	14.0227.26
14.0226.28	28.0cm	14.0227.28
14.0226.30	30.0cm	14.0227.30

ARTERY FORCEPS

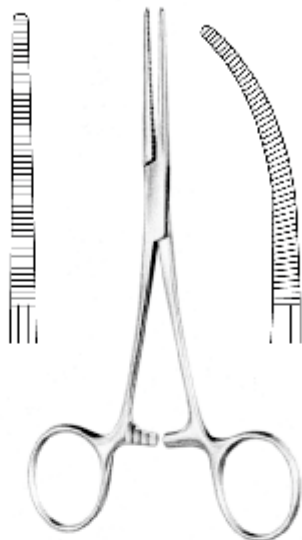

PEAN (DELICATE)

14.0230.13 13.0cm 14.0231.13
14.0230.14 14.0cm 14.0231.14
14.0230.16 16.0cm 14.0231.16

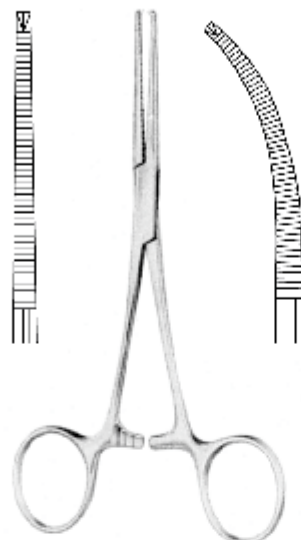

KOCHER (DELICATE)

14.0236.13 13.0cm 14.0237.13
14.0236.14 14.0cm 14.0237.14
14.0236.16 16.0cm 14.0237.16

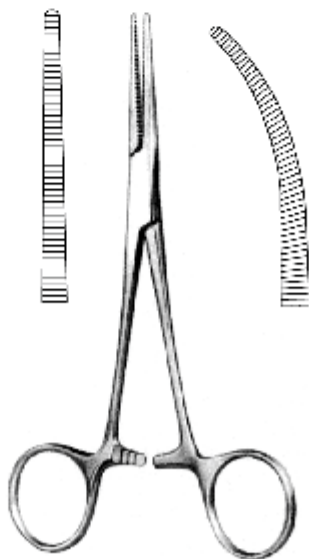

PEAN-NIPPON

14.0240.14 14.5cm 14.0241.14
14.0240.16 16.0cm 14.0241.16
14.0240.18 18.0cm 14.0241.18

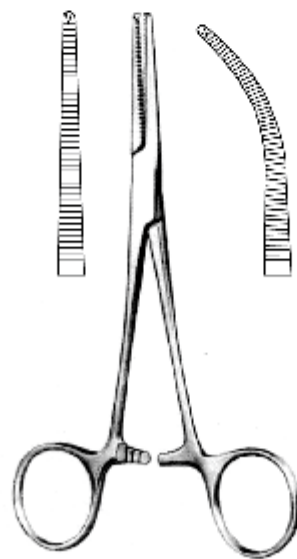

KOCHER-NIPPON

14.0246.14 14.5cm 14.0247.14
14.0246.16 16.0cm 14.0247.16
14.0246.18 18.0cm 14.0247.18

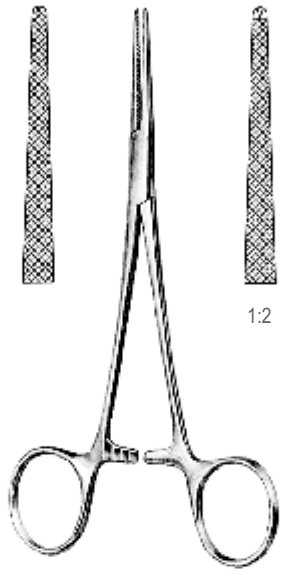

1:2

LOVELACE

14.0250.15 15.5cm 14.0252.15

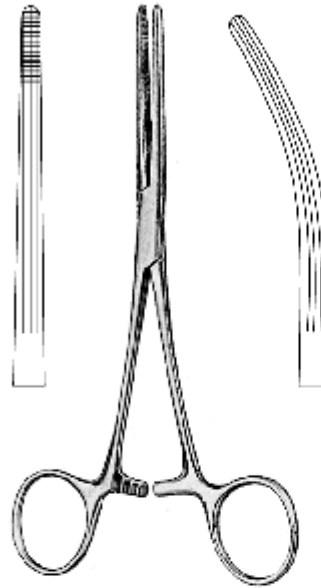

ROCHESTER-CARMALT

14.0256.16 16.0cm 14.0257.16
 14.0256.20 20.0cm 14.0257.20

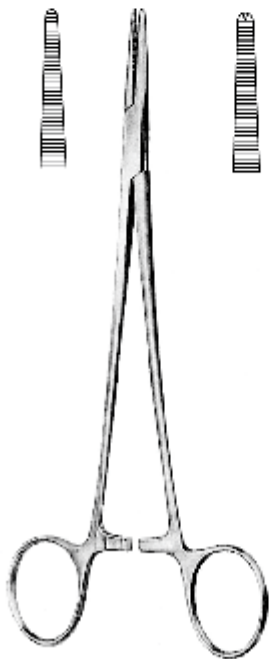

HOSEMANN

14.0260.21 21.0cm 14.0262.21

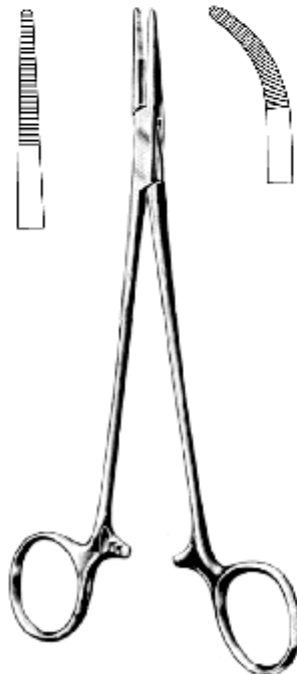

ADSON

14.0270.18 18.5cm 14.0271.18

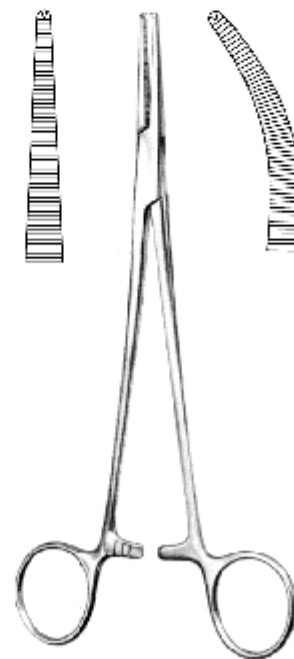

ADSON

14.0272.18 18.5cm 14.0273.18

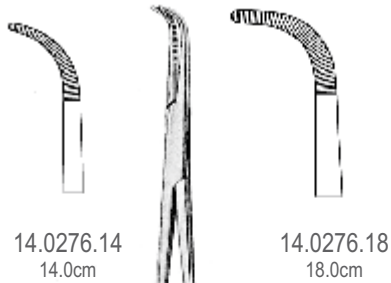

BABY-ADSON



BABY-OVERHOLT

14.0290.13 13.5cm



MIXTER BABY

14.0292.14 14.0cm

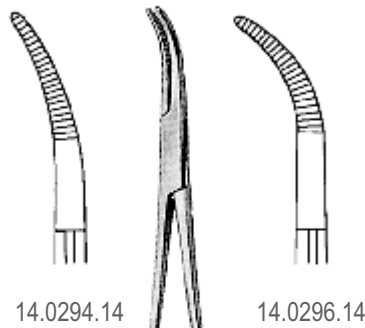

BABY-MIXTER

14.0cm



BABY-MIXTER

14.0298.18 18.0cm

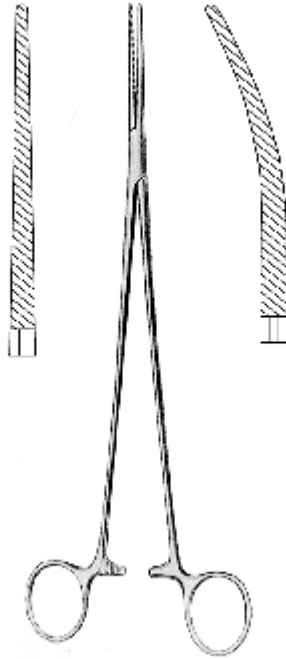

BENGOLEA

14.0300.20 20.0cm 14.0301.20
 14.0300.24 24.0cm 14.0301.24
 14.0300.26 26.0cm 14.0301.26

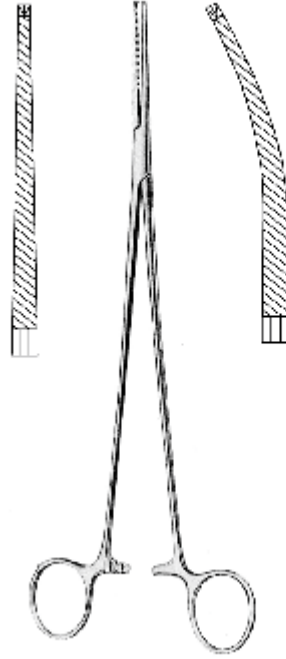

BENGOLEA

14.0302.20 20.0cm 14.0303.20
 14.0302.24 24.0cm 14.0303.24
 14.0302.26 26.0cm 14.0303.26

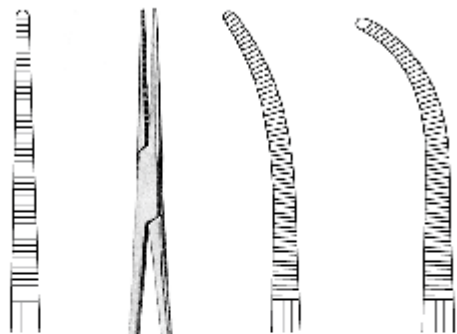

14.0310.20

14.0311.20

14.0313.20



HEISS
 20.0cm

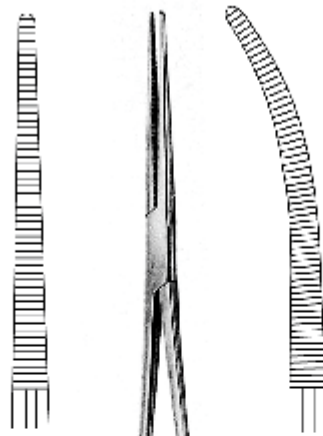

14.0316.22

14.0317.22



ROBERTS
 22.0cm

ARTERY FORCEPS

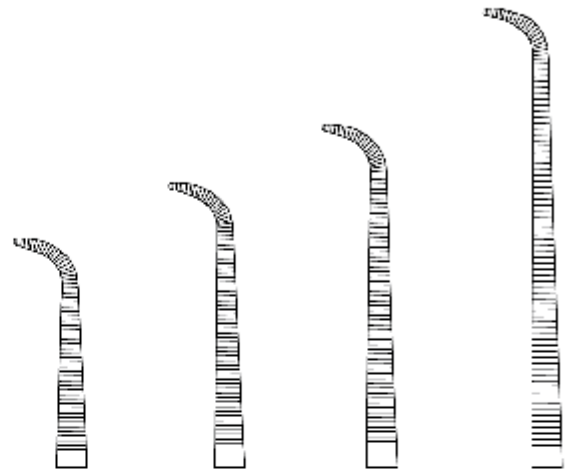



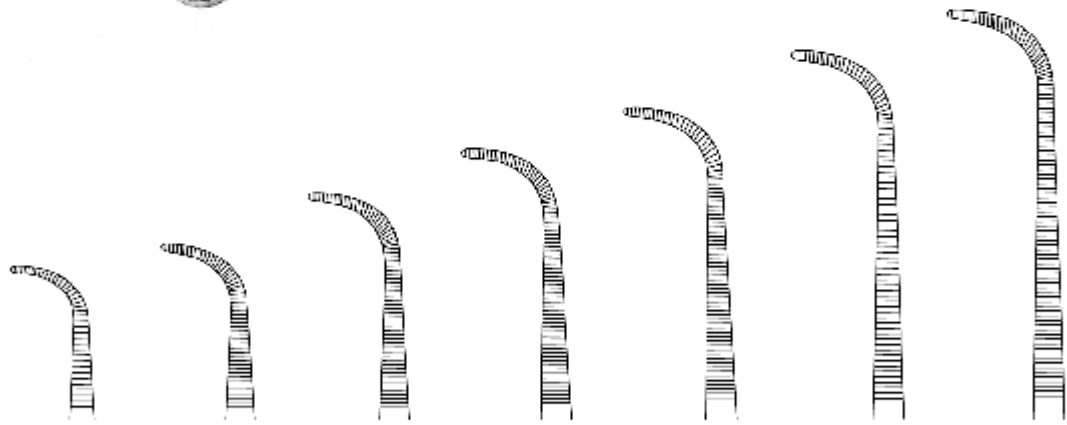

MINI-GEMINI	14.0320.18 18.0cm	14.0320.22 22.0cm	14.0320.25 25.0cm	14.0320.28 28.0cm
--------------------	----------------------	----------------------	----------------------	----------------------

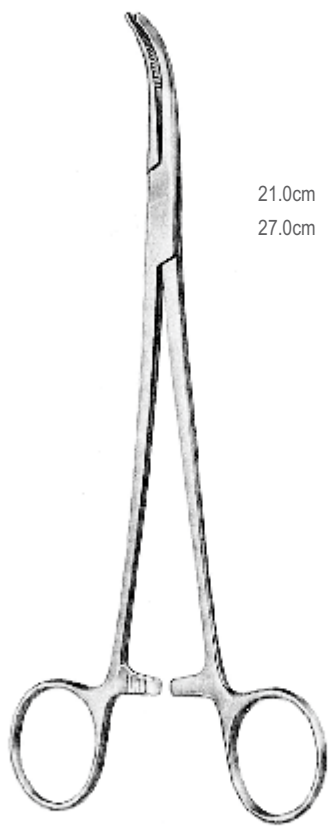

GEMINI	14.0322.13 13.0cm	14.0322.16 16.0cm	14.0322.18 18.0cm	14.0322.20 20.0cm	14.0322.23 23.0cm	14.0322.25 25.0cm	14.0322.28 28.0cm
---------------	----------------------	----------------------	----------------------	----------------------	----------------------	----------------------	----------------------

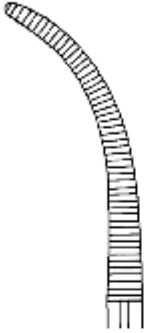
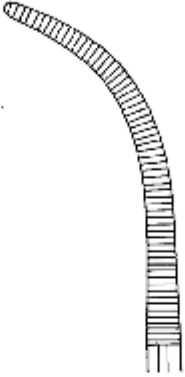
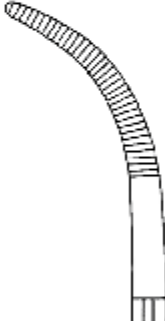
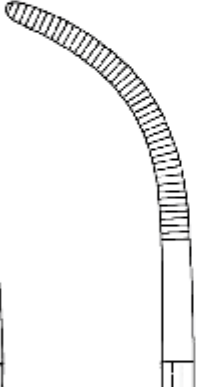

OVERHOLT-GEISSENDOERFER

				
21.0cm	14.0331.21	14.0332.21	14.0333.21	14.0334.21
27.0cm	14.0331.27	14.0332.27	14.0333.27	14.0334.27
				
21.0cm	14.0335.21	14.0336.21	14.0337.21	
27.0cm	14.0335.27	14.0336.27	14.0337.27	

ARTERY FORCEPS



OVERHOLT

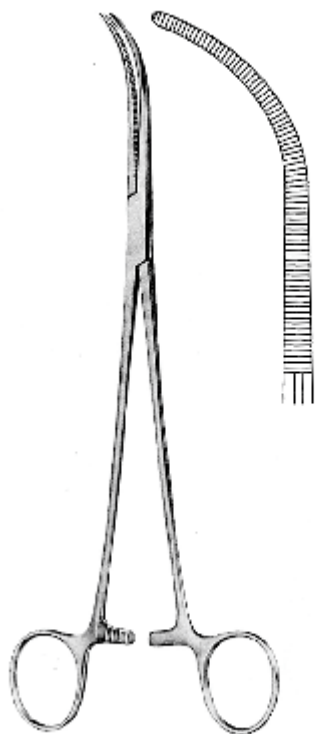
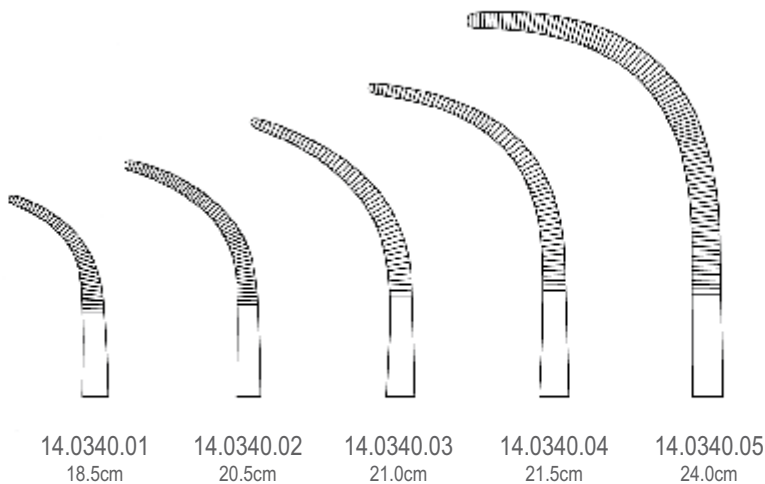

OVERHOLT-MIXTER
14.0342.21 21.0cm

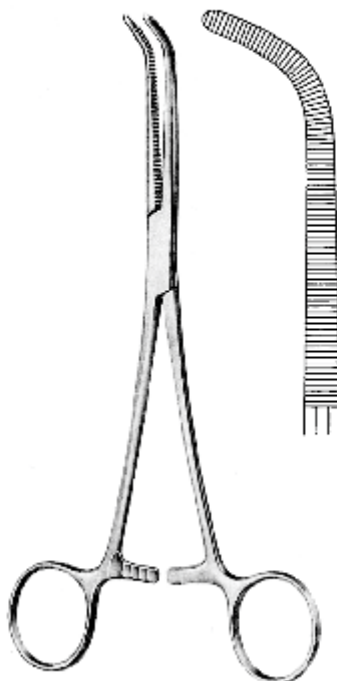

MIXTER
14.0344.22 22.0cm

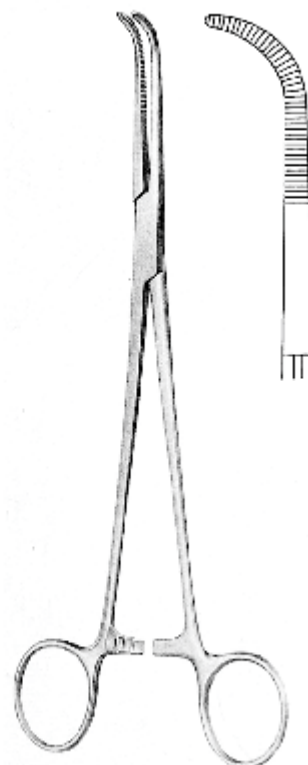

MIXTER
14.0346.23 23.0cm

Artery Forceps, Dissecting and ligature Forceps
 Arterienklemmen, Präparier- und Ligaturklemmen
 Pinzas hemostáticas, pinzas para preparaciones y ligaduras
 Зажимы артериальные
 分离结扎钳



ARTERY FORCEPS

KELLY

19.0 cm 14.0350.19 14.0351.19 14.0353.19
 22.0 cm 14.0350.22 14.0351.22 14.0353.22
 24.0 cm 14.0350.24 14.0351.24 14.0353.24

MEEKER

14.0356.27 27.5 cm

LAWRENCE

14.0358.27 27.5 cm

ARTERY FORCEPS

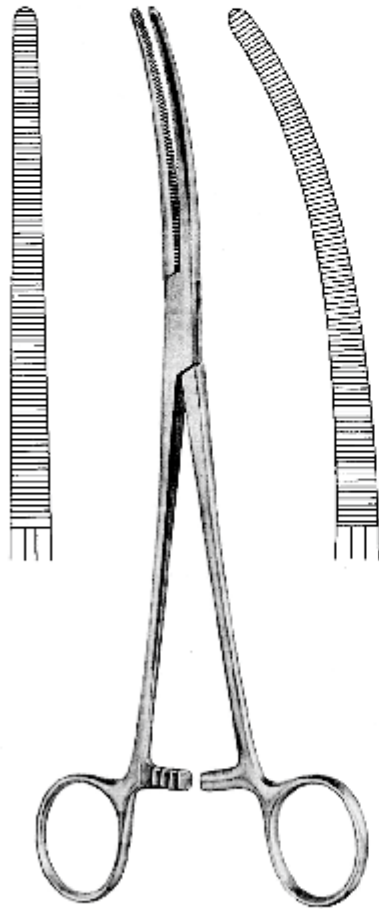

SAROT
14.0360.24 24.0cm 14.0361.24

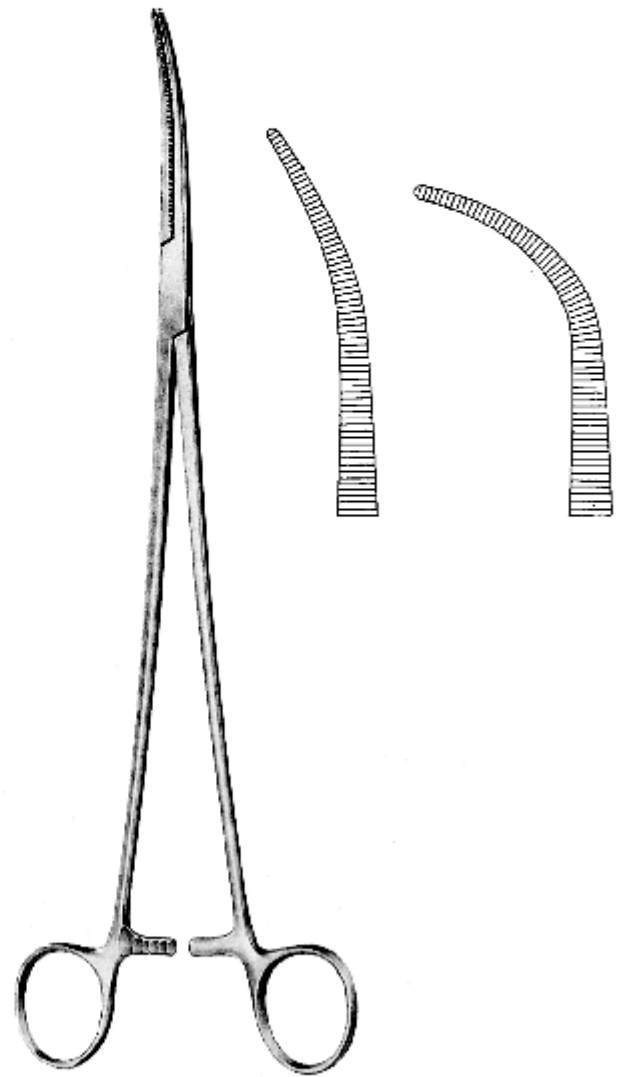

ZENKER
14.0366.01 29.5cm 14.0366.02

Artery Forceps, Dissecting and ligature Forceps
 Arterienklemmen, Präparier- und Ligaturklemmen
 Pinzas hemostáticas, pinzas para preparaciones y ligaduras
 Зажимы лигатурные
 扁桃体止血钳、分离结扎钳

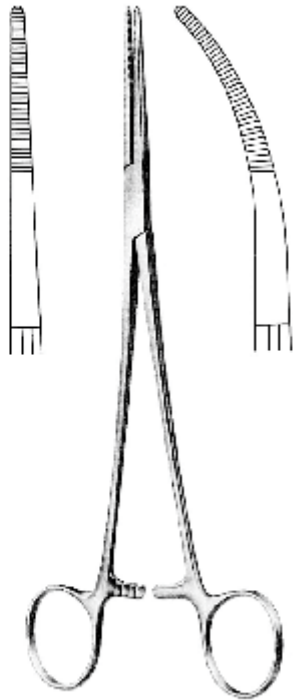

TOENNIS

14.0370.21 21.0cm 14.0371.21
 14.0370.26 26.0cm 14.0371.26

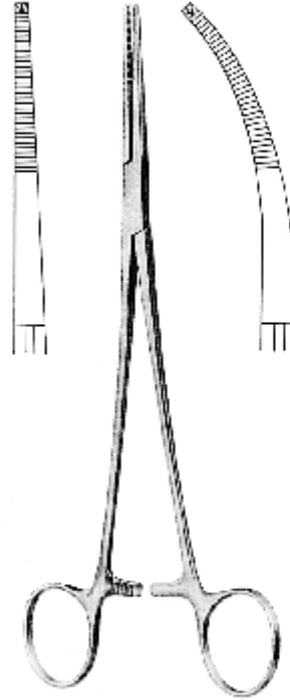

TOENNIS

14.0372.21 21.0cm 14.0373.21
 14.0372.26 26.0cm 14.0373.26

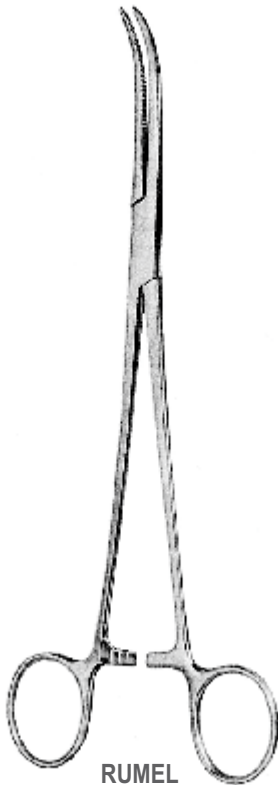

RUMEL
 23.0cm

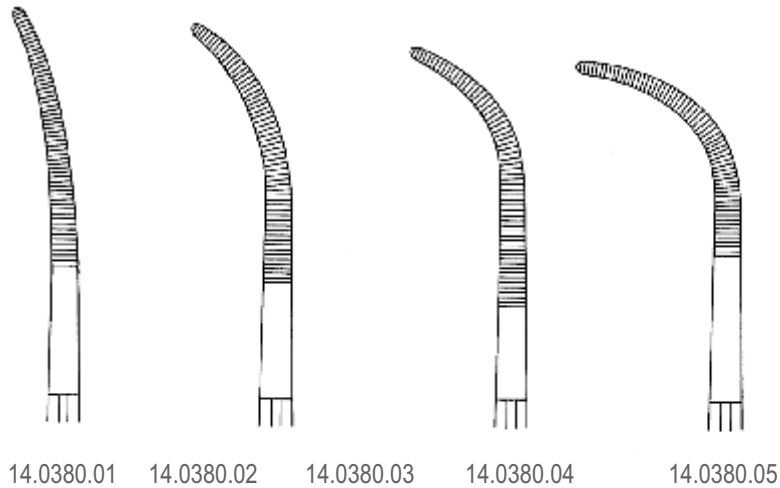

14.0380.01 14.0380.02 14.0380.03 14.0380.04 14.0380.05

ARTERY FORCEPS

ARTERY FORCEPS

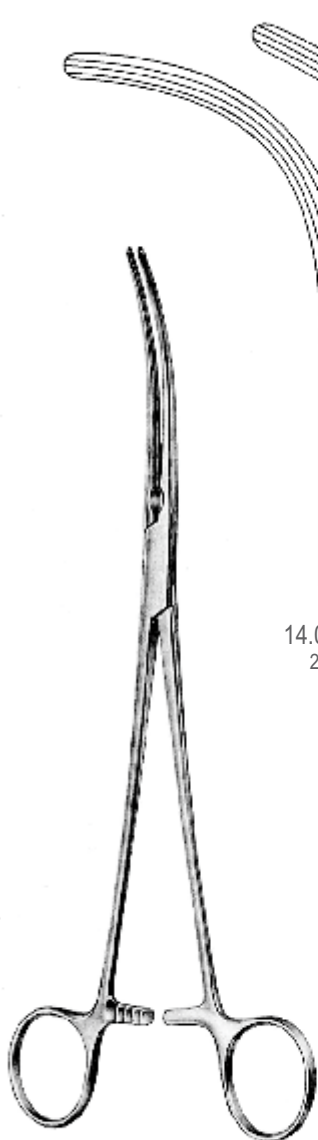

CRAFOORD-SELLORS

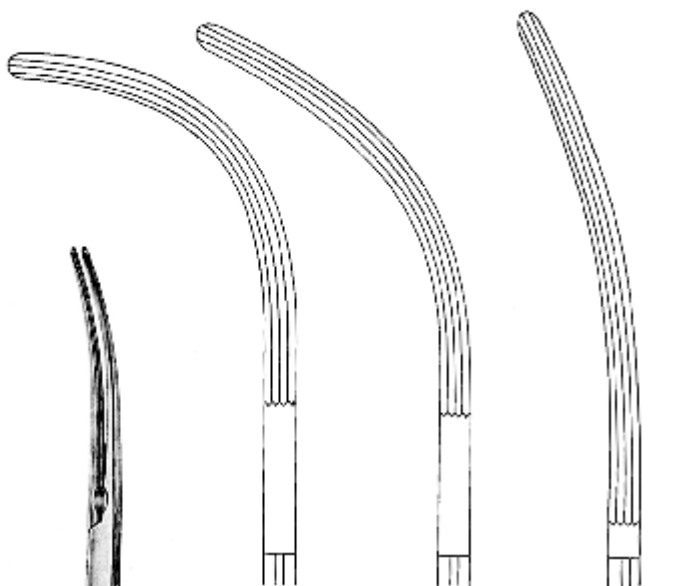

14.0386.01
22.0cm

14.0386.02
23.0cm

14.0386.03
24.0cm

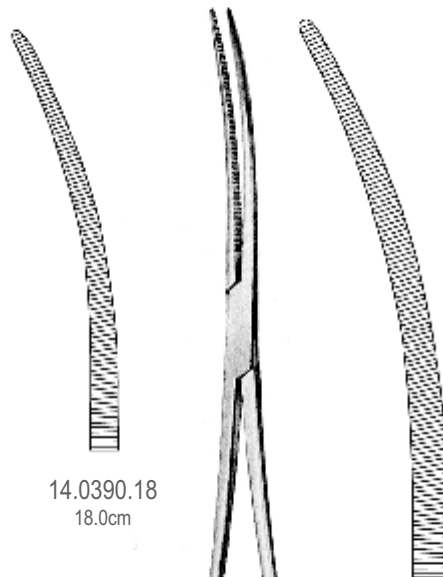

14.0390.18
18.0cm

14.0390.24
24.0cm

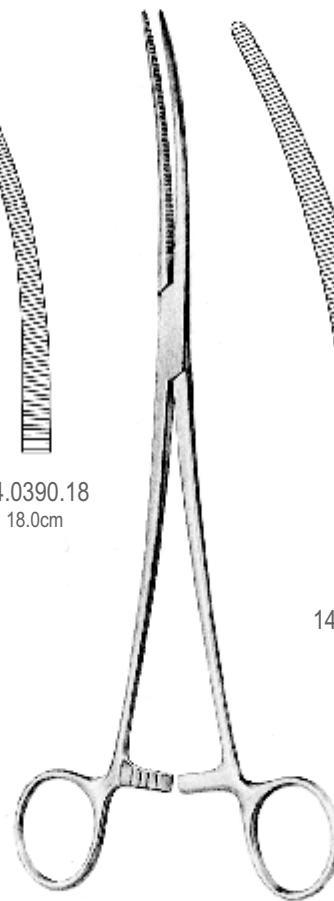

CRAFOORD

Artery Forceps, Gall Duct and Kidney Pedicle Clamp Forceps
 Arterien-Gallenkanal-und Nierenstielklemmen
 Pinzas-gallenkanal-und nierenstielklemmen
 Зажимы для желчных протоков
 动脉钳，胆管和肾蒂钳钳

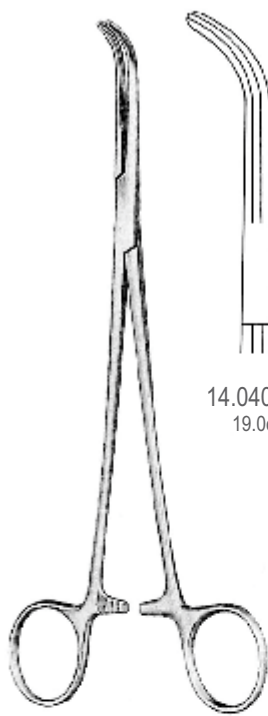

14.0400.19 19.0cm
 14.0400.23 23.0cm

LAHEY

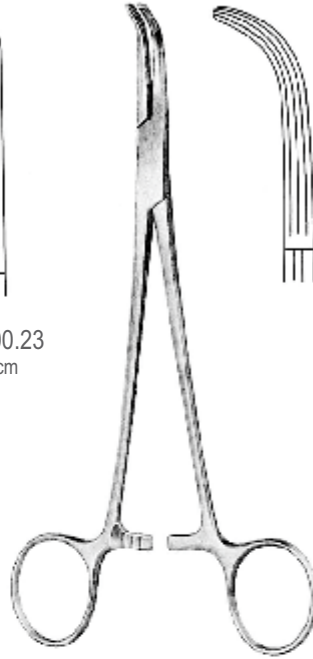

LOWER
 14.0406.18 18.0cm

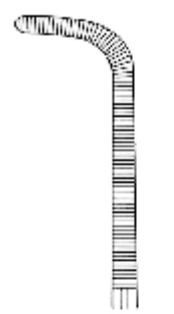

14.0410.21
 21.0cm

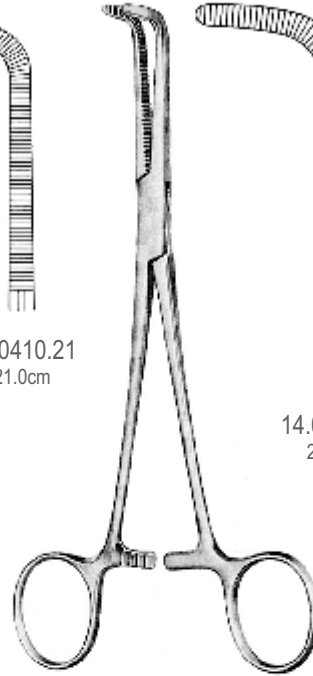

WICKSTRÖM

14.0410.24
 24.0cm

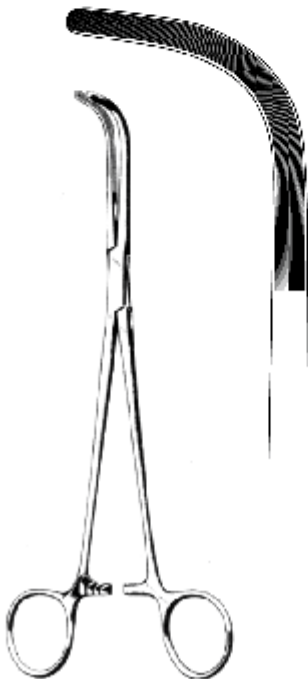

McQUIGG-MIXTER
 14.0416.22 22.0cm

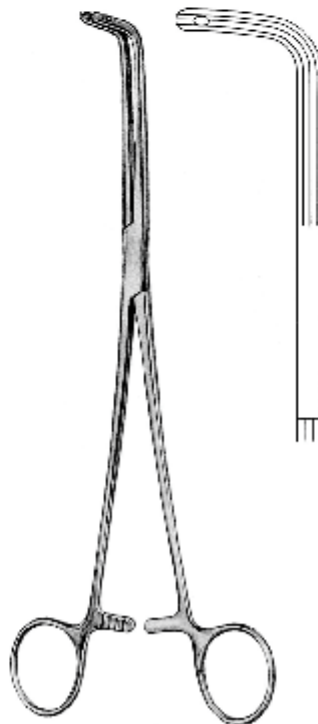

FINOCHIETTO
 14.0420.24 24.0cm

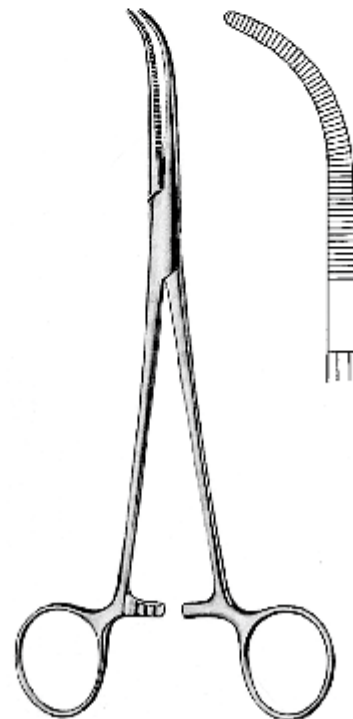

JOHNS HOPKINS
 14.0426.20 20.0cm

ARTERY FORCEPS

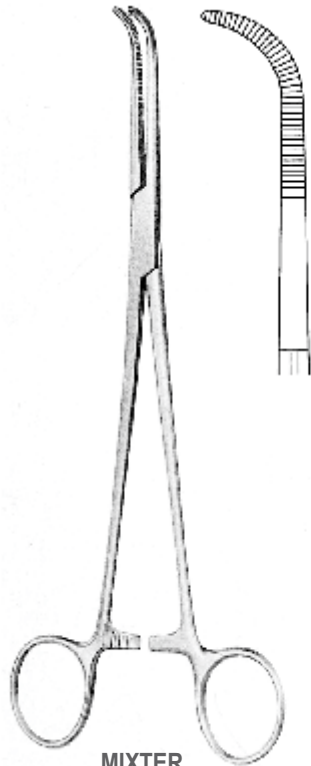

MIXTER

14.0430.15 15.0cm
14.0430.19 19.0cm

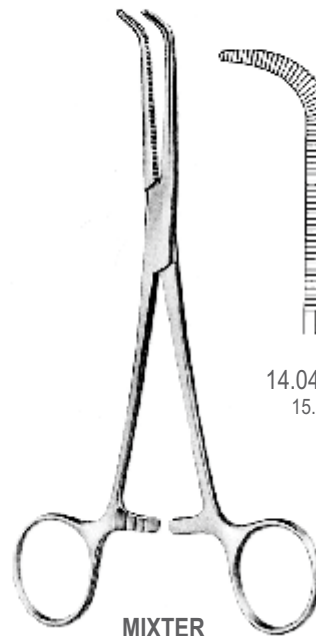

MIXTER

14.0432.15
15.5cm

14.0432.18
18.0cm

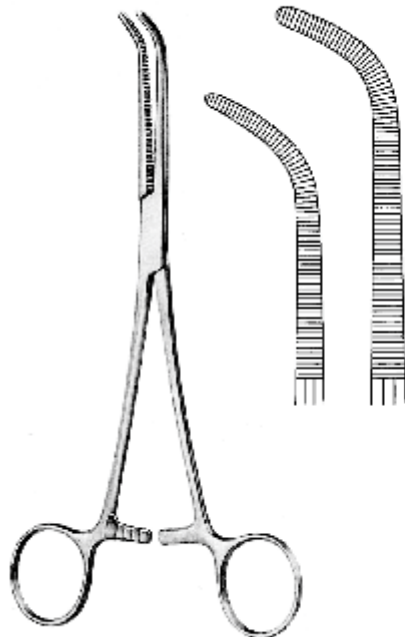

MIXTER-O'SHAUGHNESSY

14.0434.18 18.0cm
14.0434.22 22.0cm

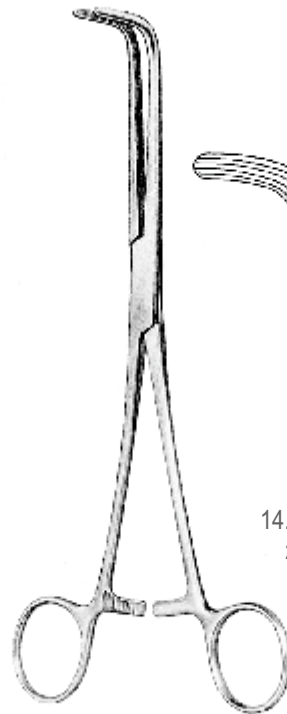

MIXTER

14.0441.22
22.0cm

14.0441.25
25.0cm

14.0441.28
28.0cm

Kidney Pedicle Clamps Forceps
 Nierenstielklemmen
 Pinzas-clamps para pedunculos renales
 Зажимы для почечной ножки
 肾蒂钳

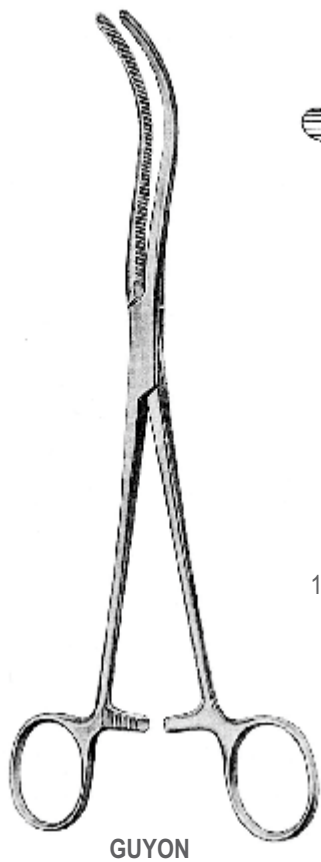

GUYON

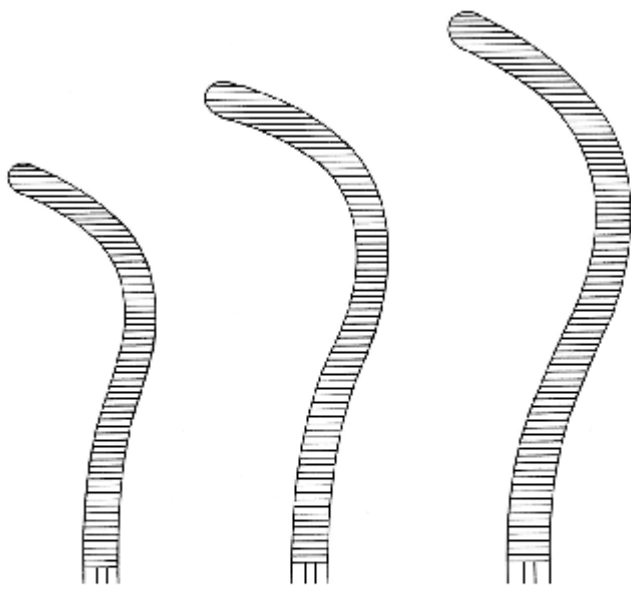

14.0450.20 20.0cm 14.0450.22 22.0cm 14.0450.24 24.0cm

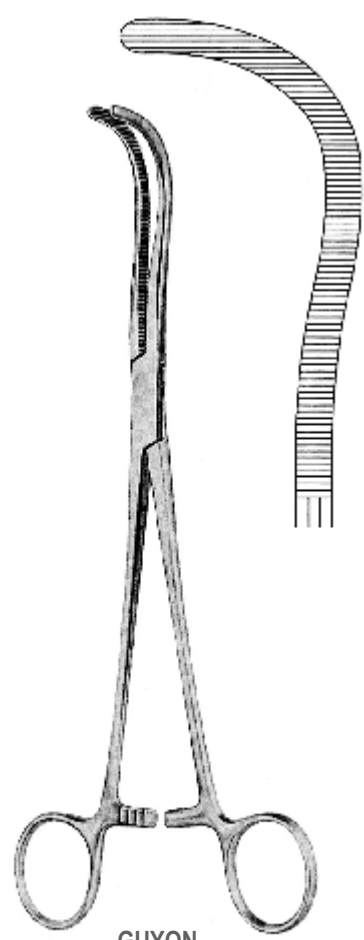

GUYON

14.0452.23 23.0cm

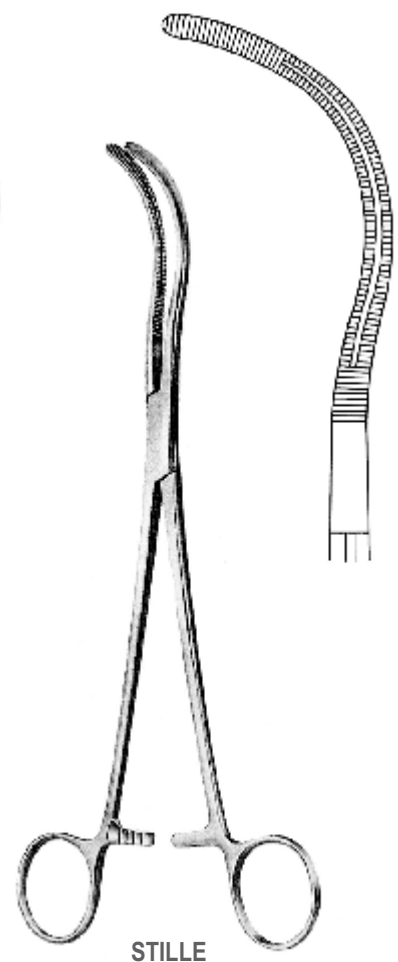

STILLE

14.0454.23 23.0cm

ARTERY FORCEPS

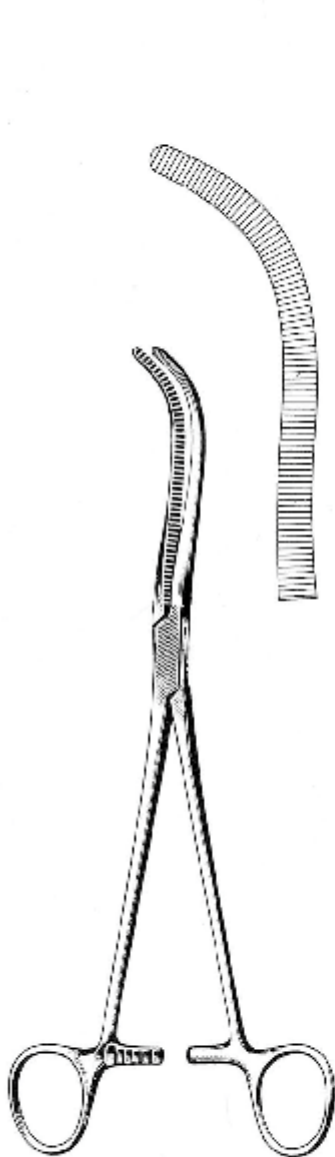

MAYO
14.0456.23 23.0cm

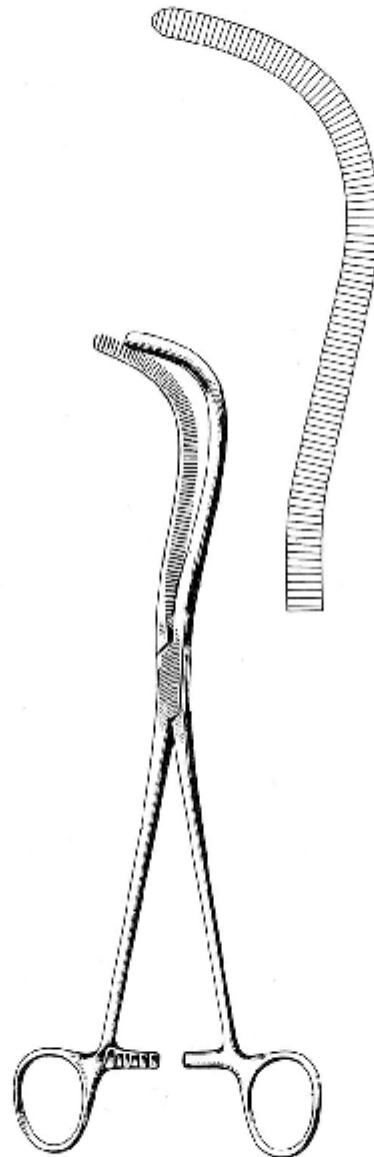

MAYO-GUYON
14.0458.23 23.0cm

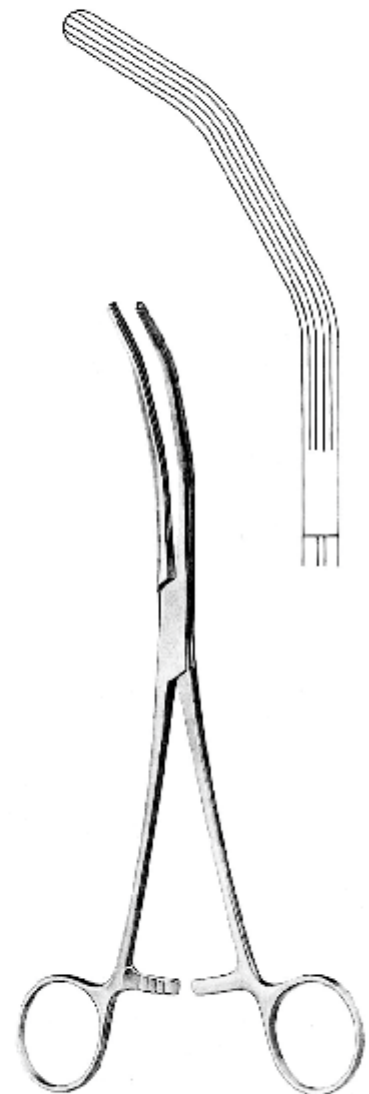

HERRICK
14.0460.23 23.0cm

Gall Duct Forceps
Gallenkanalklemmen
Pinzas para conducto biliar
Зажимы для желчных протоков
胆囊钳

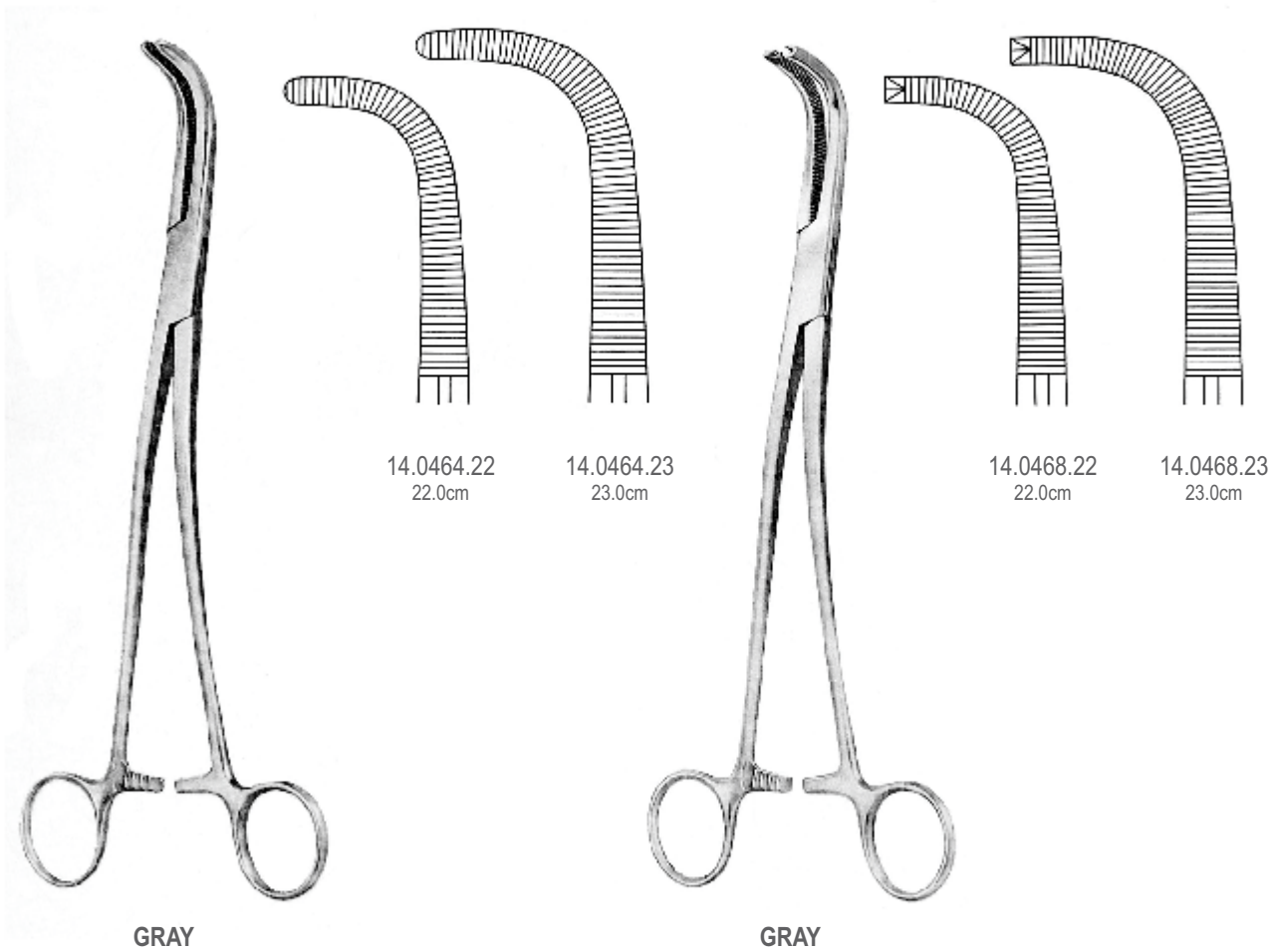

ARTERY FORCEPS





DESJARDINS
14.0470.21 21.0cm

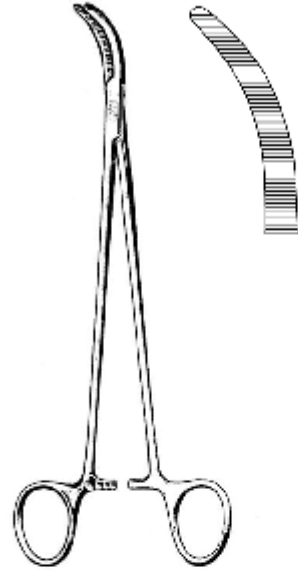

DESJARDINS
14.0472.21 21.0cm

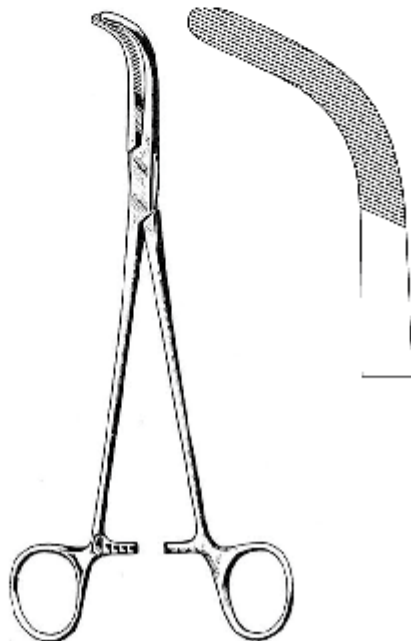

CRILE
14.0476.20 20.0cm

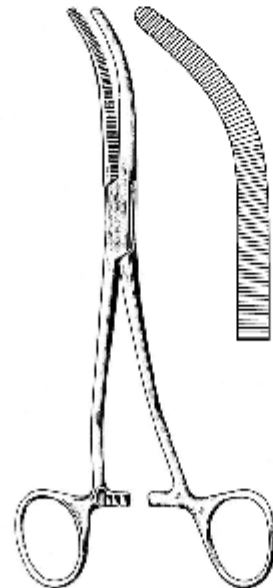

DEAN-SHALLCROSS
14.0480.18 18.0cm

Tangential Forceps, Kidney Pedicle Clamps Forceps
Tangentialklemmen, Nierenstielklemmen
Pinzas tangenciales, pinzas-clamps para pedunculos Renales
Зажимы для почечной ножки
切钳，肾蒂钳钳



ATRAUMA

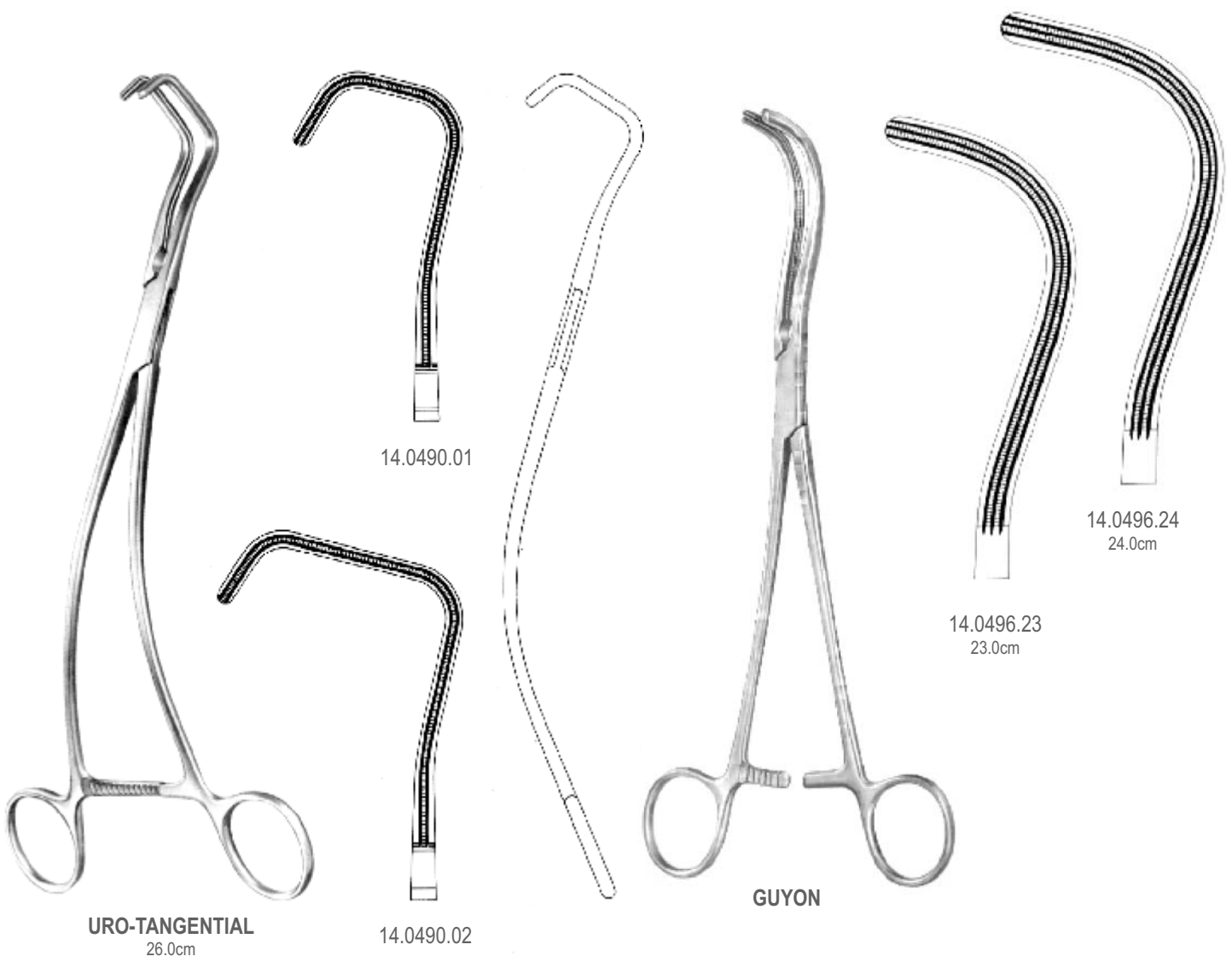



BABY-MIKULICZ
14.0500.14 14.0cm

MIKULICZ
14.0500.18 18.0cm

MIKULICZ
14.0500.20 20.0cm

MIKULICZ
14.0502.20 20.0cm

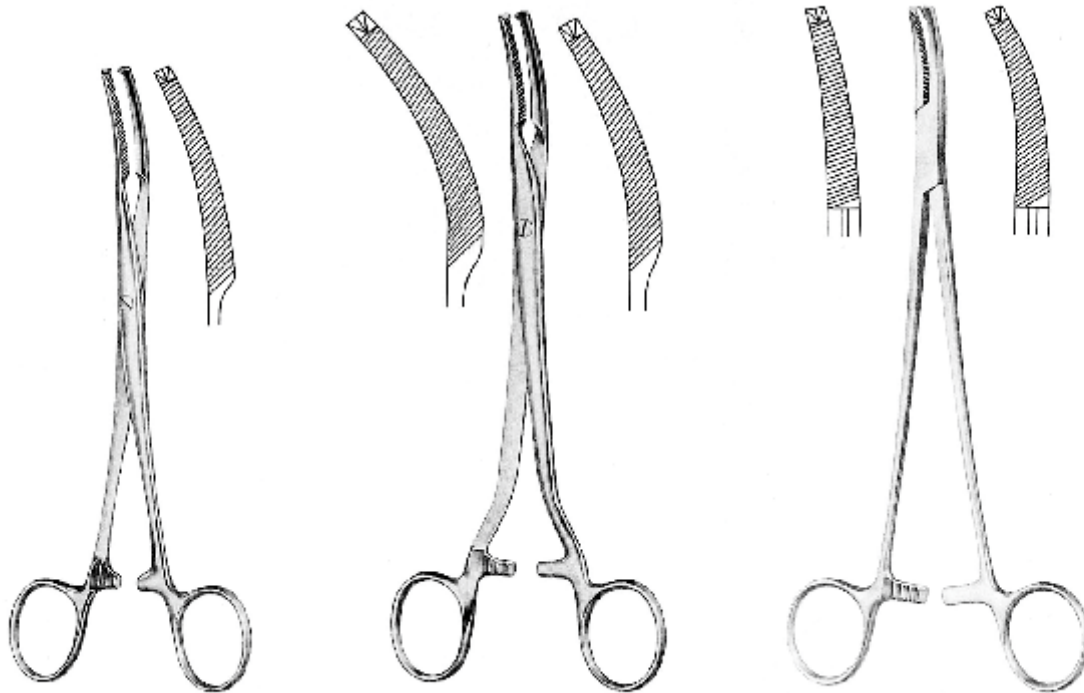

MIKULICZ
14.0504.18 18.0cm

MIKULICZ
14.0506.20 20.0cm 14.0508.20

FAURE
14.0512.20 20.0cm 14.0514.20

Hysterectomy Forceps
 Hysterektomieklemmen
 Pinzas Para Histerectomia
 Зажимы для гистерэктомии
 子宫切除术钳



HEANEY

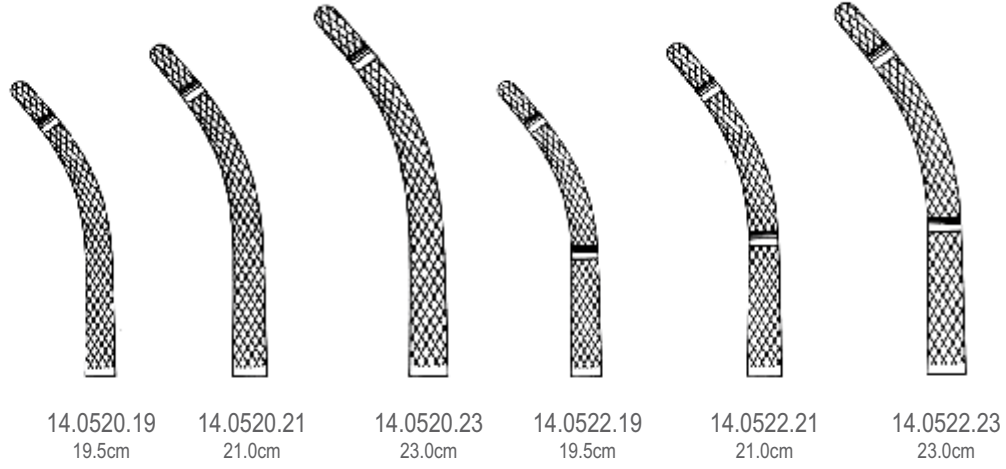

14.0520.19
19.5cm

14.0520.21
21.0cm

14.0520.23
23.0cm

14.0522.19
19.5cm

14.0522.21
21.0cm

14.0522.23
23.0cm

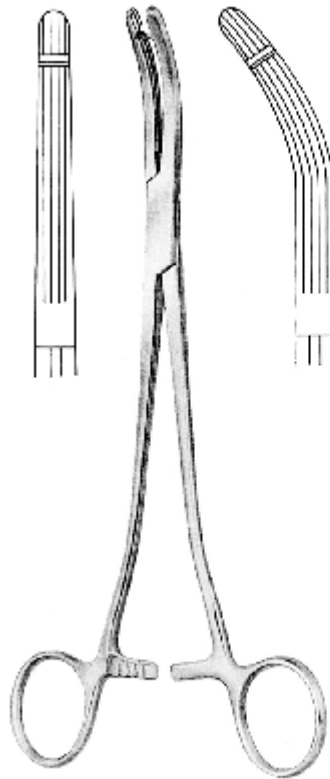

HEANEY-BALLENTINE
14.0526.21 21.0cm 14.0527.21

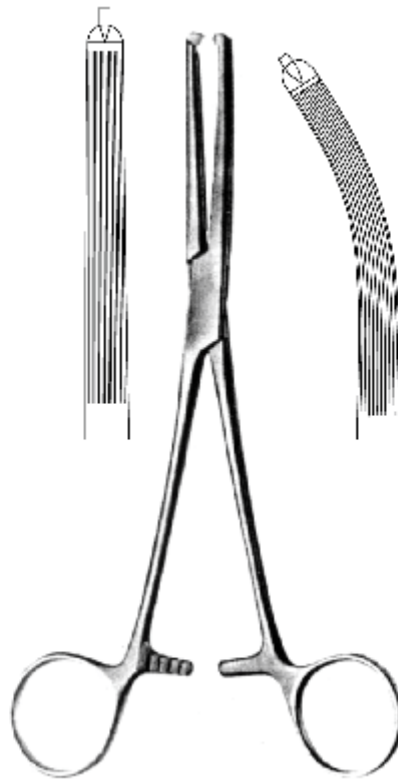

GWILLIAM
14.0530.20 20.0cm 14.0531.20

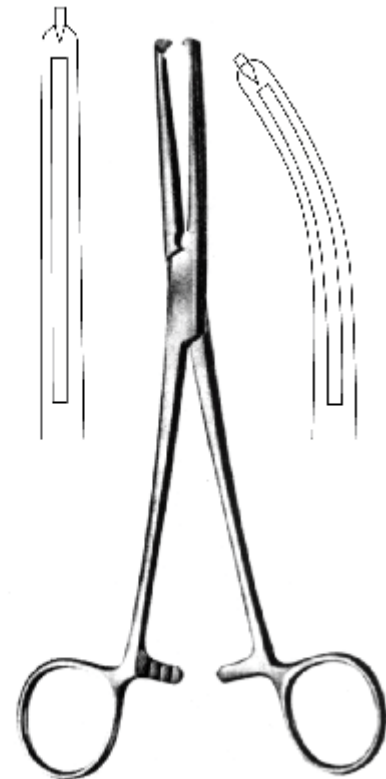

MAINGOT
14.0536.20 20.0cm 14.0537.20

ARTERY FORCEPS

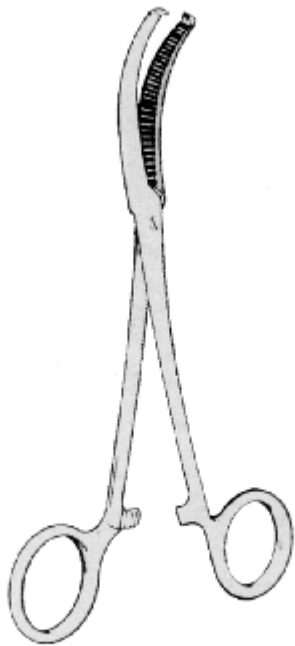

BERKELEY
14.0540.20 20.0 cm



BERKELEY BONNEY
14.0544.19 19.0 cm



BONNEY
14.0548.20 20.5 cm

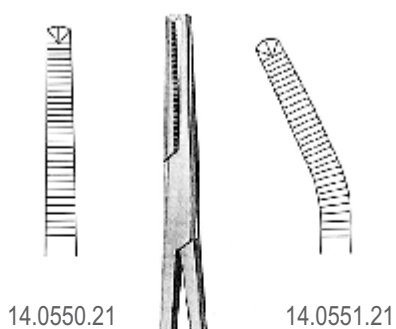

14.0550.21

14.0551.21

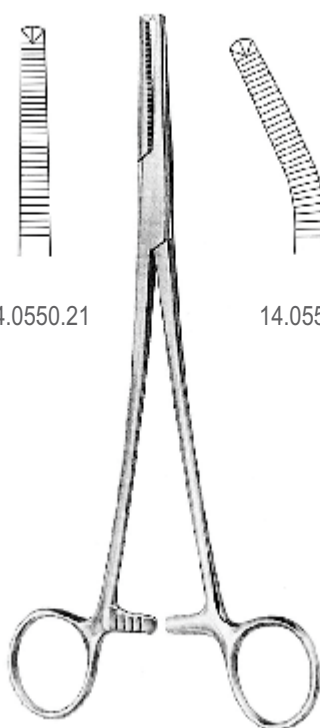

PHANEUF
21.0cm

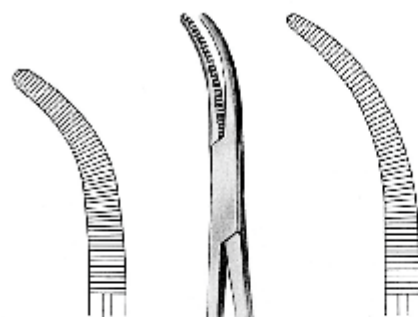

14.0556.23
23.0 cm

14.0556.24
24.0 cm

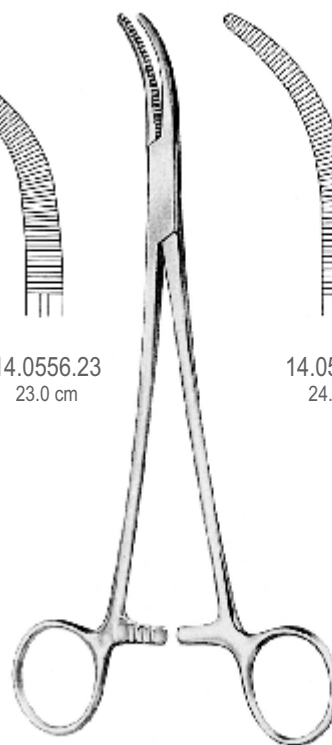

MOYNIHAN

Clamps-Forceps, Hysterectomy and Vaginal Forceps
 Klemmzangen, Hysterektomieklemmen, Vaginalklemmen
 Pinzas-clamps, pinzas-clamps para histerectoia y vaginales
 Зажимы влагалищные
 夹具, 钳, 子宫和阴道钳

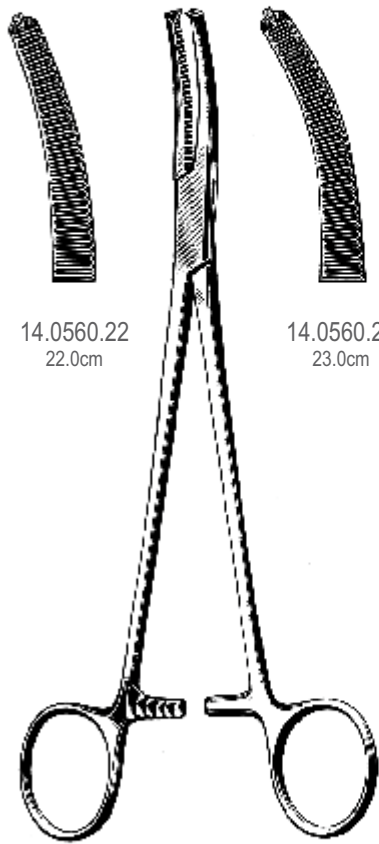

14.0560.22
22.0cm

WERTHEIM



14.0560.23
23.0cm

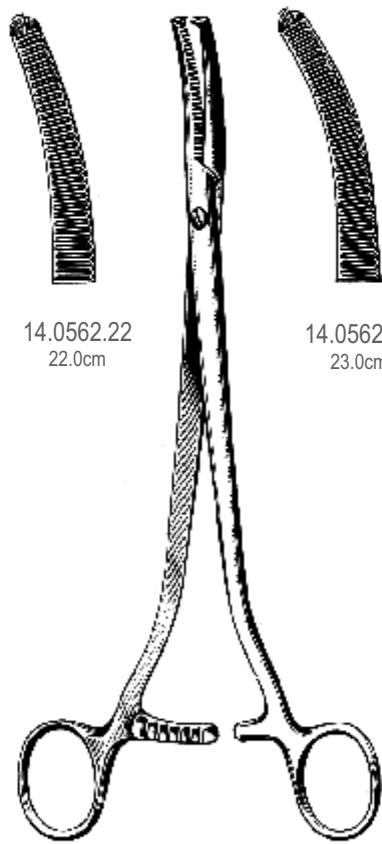

14.0562.22
22.0cm

WERTHEIM



14.0562.23
23.0cm



14.0566.24
24.0cm

WERTHEIM

ARTERY FORCEPS

ARTERY FORCEPS

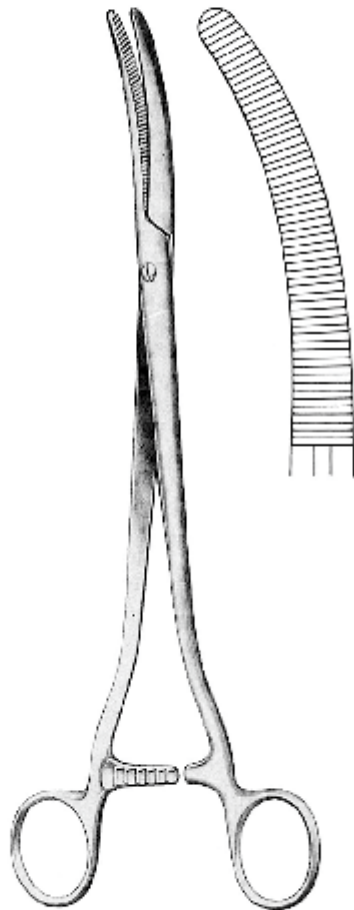

FAURE
14.0570.25 25.0cm

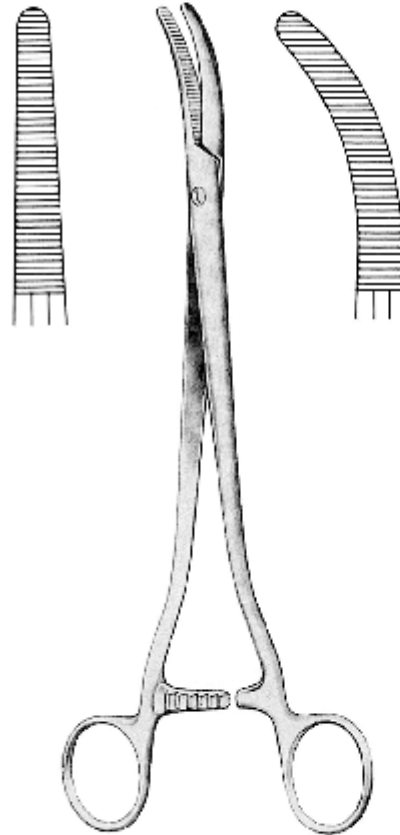

SEGOND-LANDAU
14.0576.24 24.0cm 14.0577.24

Clamps-Forceps, Hysterectomy and Vaginal Forceps
Klemmzangen, Hysterektomieklemmen, Vaginalklemmen
Pinzas-clamps, pinzas-clamps para histerectoia y vaginales
Зажимы влагалищные
夹具, 钳, 子宫和阴道钳

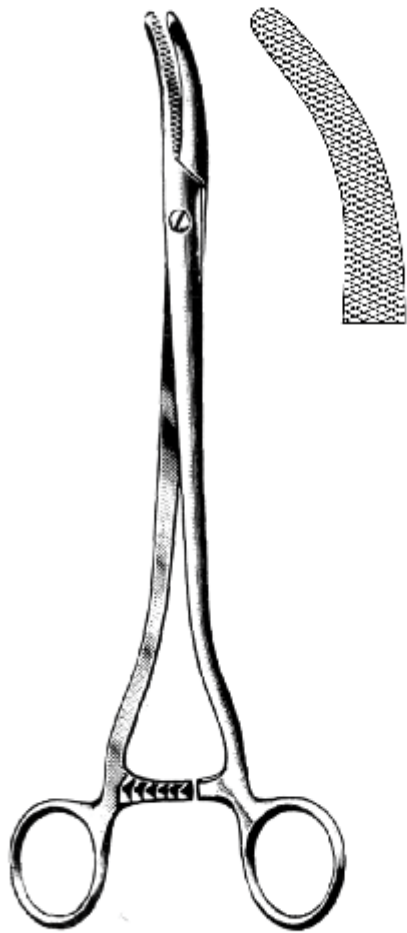

WERTHEIM
14.0580.25 25.0cm

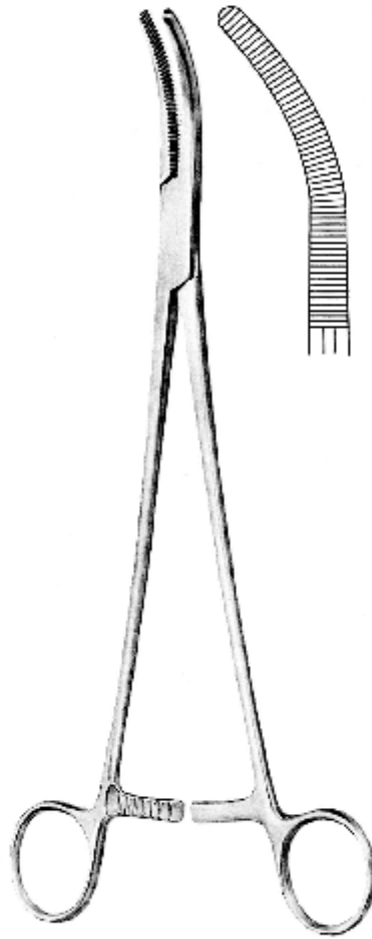

WERTHEIM
14.0582.25 25.0cm

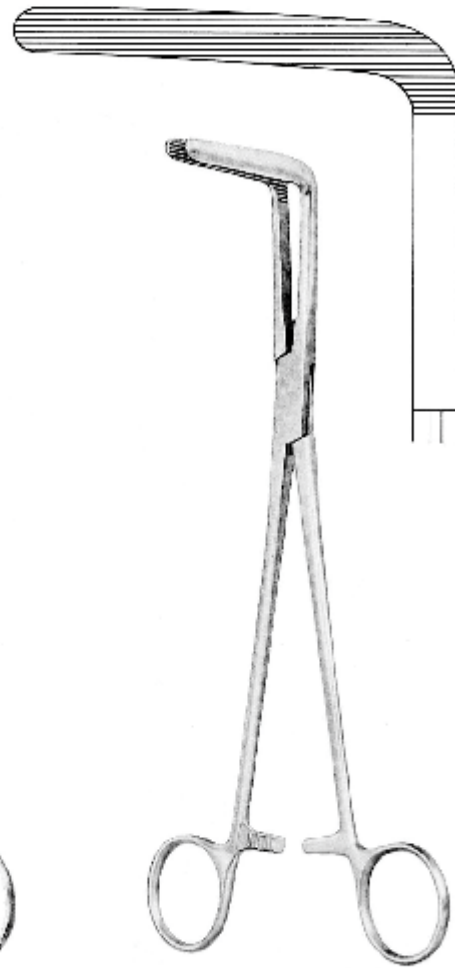

WERTHEIM-CULLEN
14.0586.21 21.5cm

ARTERY FORCEPS

ATRAUMA

ARTERY FORCEPS

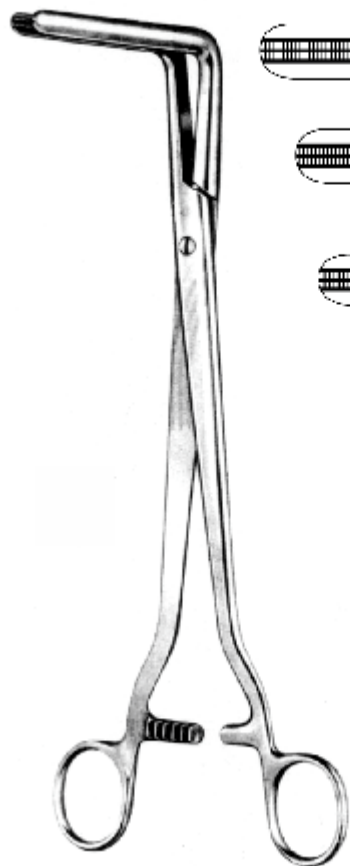

WERTHEIM
24.0cm

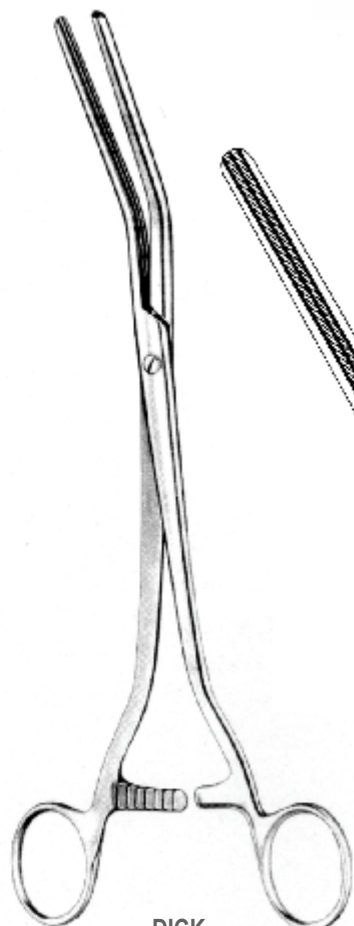
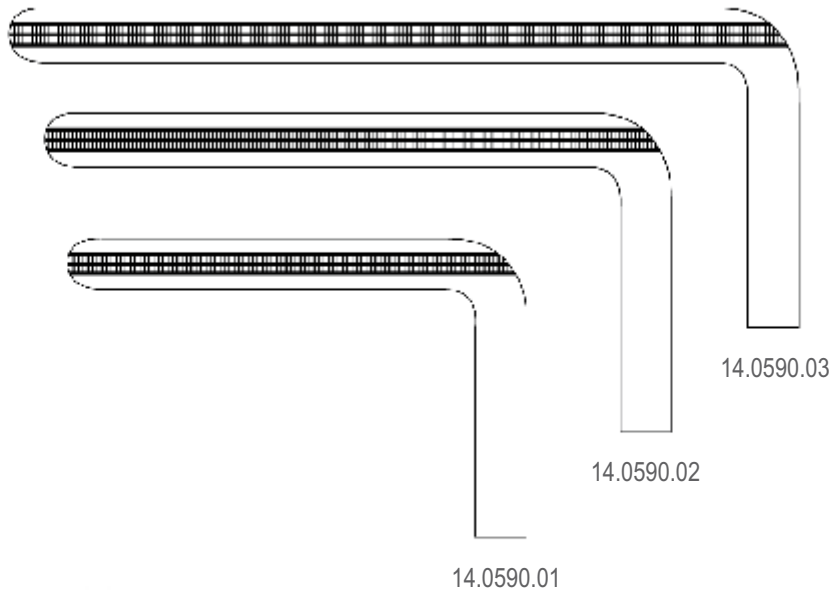

DICK

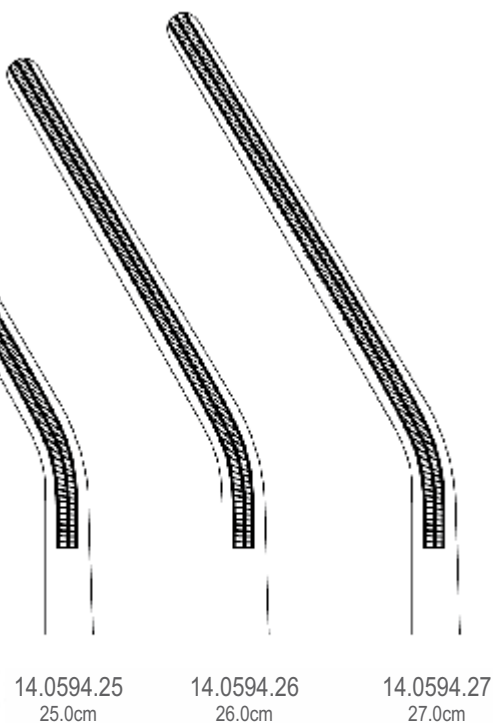

Hysterectomy Forceps
Hysterektomieklemmen
Pinzas-clamps para hysterectomia
Зажимы для гистерэктомии
子宫切除术钳



ATRAUMA



ROGERS

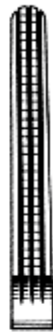

14.0600.01
22.0cm



14.0600.02
21.5cm



14.0600.03
21.0cm

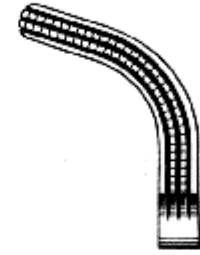

14.0600.04
20.5cm



14.0602.01
25.0cm



14.0602.02
25.0cm

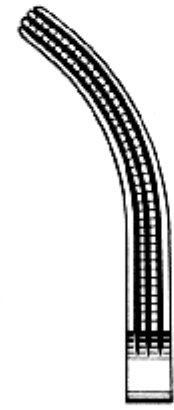

14.0602.03
24.5cm

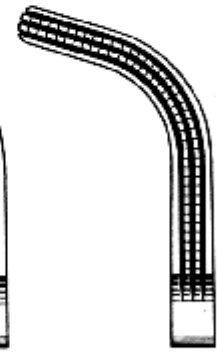

14.0602.04
23.0cm

ARTERY FORCEPS

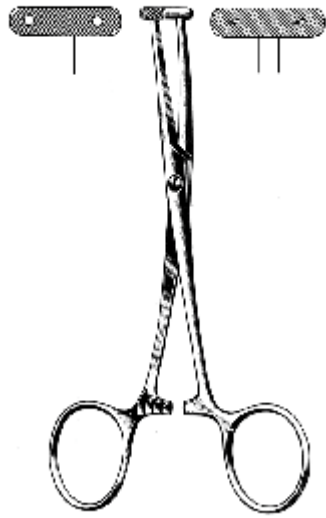

MARTEL
14.0620.14 14.0cm

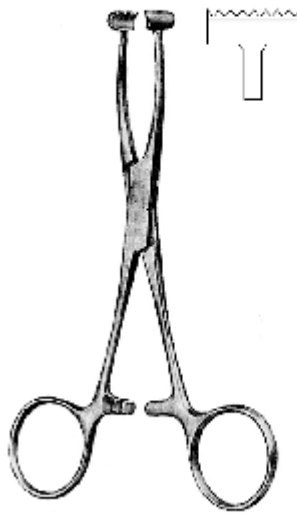

PRATT
14.0624.15 15.0cm

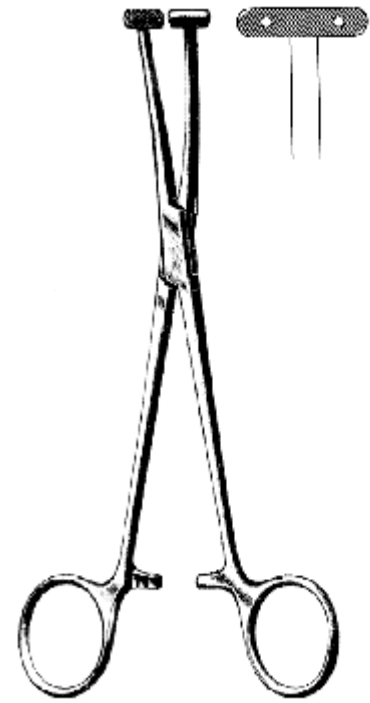

WILLET-MARTEL
14.0628.19 19.0cm

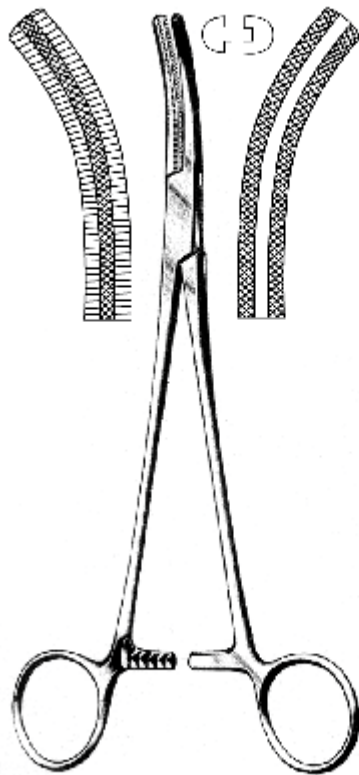

BUIE
14.0630.21 21.0cm

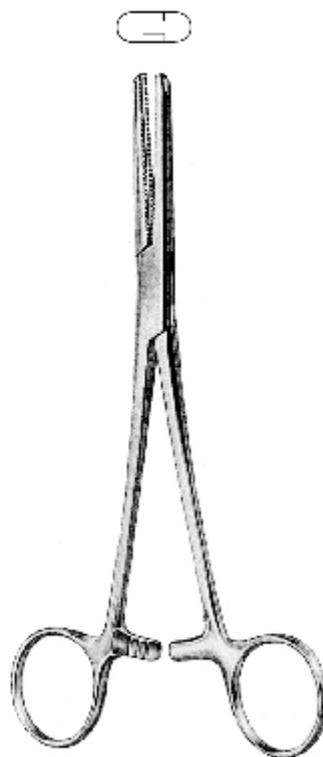

FERGUSSON

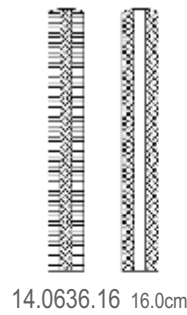

14.0636.16 16.0cm

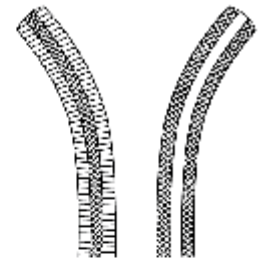

14.0637.16 16.0cm

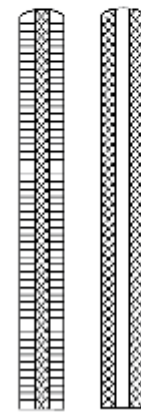

14.0636.20 20.0cm

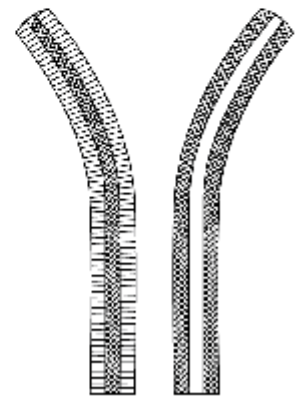

14.0637.20 20.0cm

Artery Forcep, Tumor Seizing Forceps
 Arterienklemmen, Tumorfassklemmen
 Pinzas hemostaticas, pinzas para sacar tumores
 Щипцы для захвата опухоли
 组织夹持钳

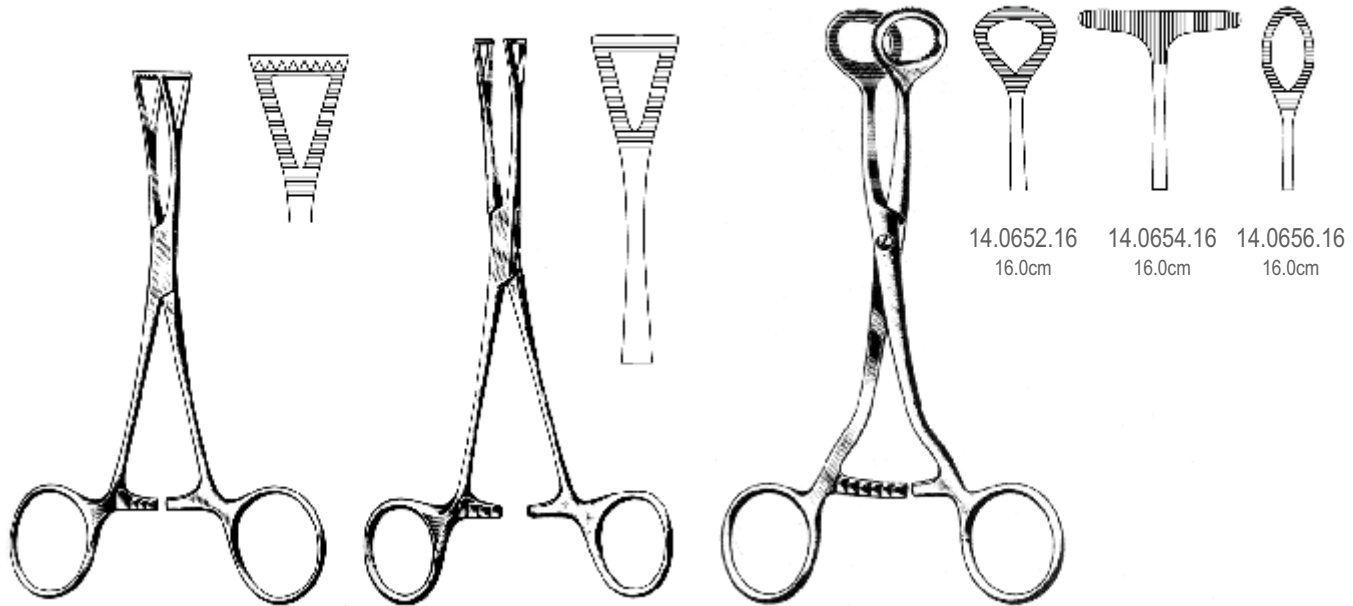

COLLIN
 14.0640.14 14.0cm

PENNINGTON
 14.0646.15 15.5cm
 14.0646.20 20.0cm

COLLIN
 14.0650.16 16.0cm

14.0652.16 16.0cm
 14.0654.16 16.0cm
 14.0656.16 16.0cm

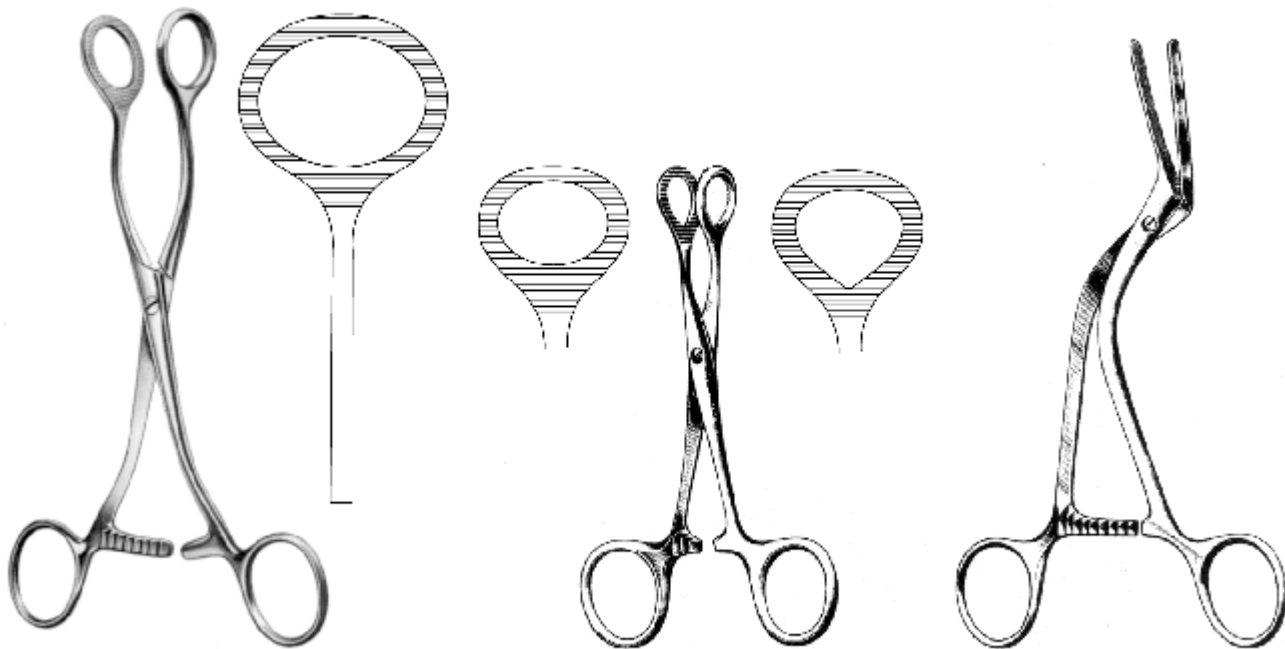

COLLIN
 14.0658.16 16.5cm

PEAN
 14.0660.12 12.0cm 14.0662.12

HOPFNER
 14.0666.16 16.0cm

ARTERY FORCEPS

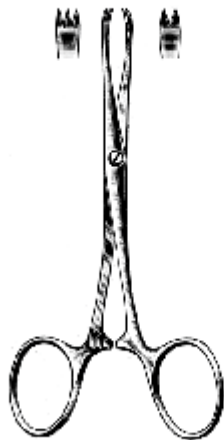

CHAPUT
14.0670.13 13.0cm

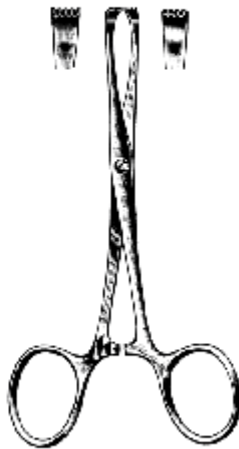

TUFFIER
14.0674.13 13.0cm

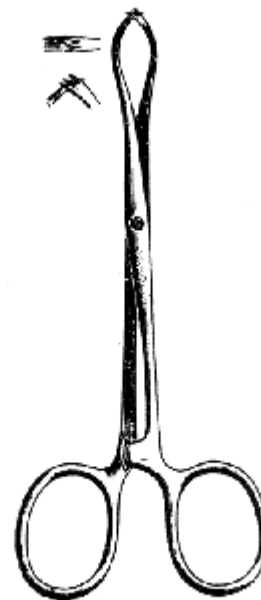

PORRIER
14.0678.12 12.5cm
14.0678.18 18.0cm



LANE
14.0680.12 12.5cm
14.0680.15 15.0cm
14.0680.19 19.5cm

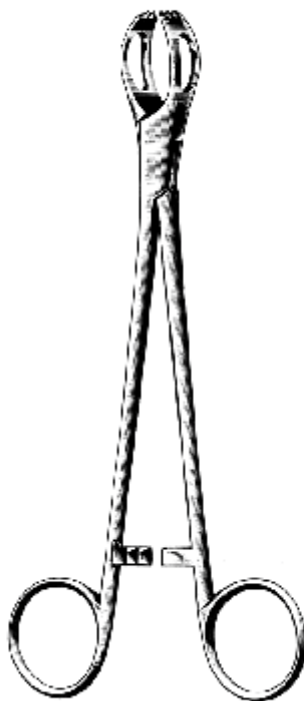

LANE
14.0682.12 12.5cm
14.0682.15 15.0cm
14.0682.20 20.0cm



ATRAUMA



14.0686.25 25.0cm



14.0688.26 26.0cm

Tubing Clamp
 Schlauchklemmen
 Pinzas para tubos
 Зажимы для трубок
 管夹

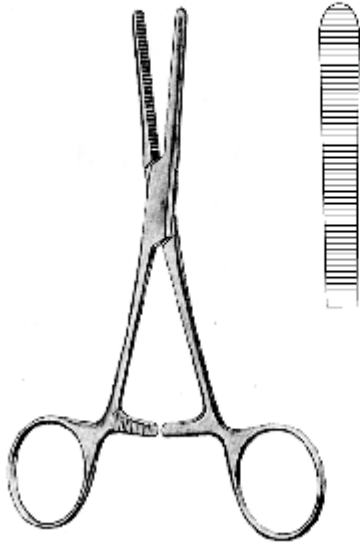

14.0690.14 14.5cm

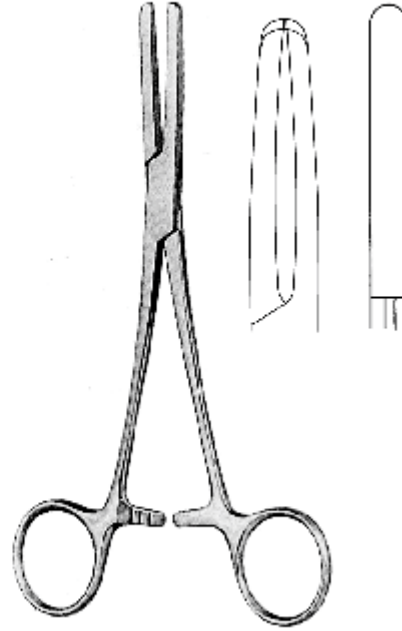

14.0692.16 16.5cm
 14.0692.18 18.0cm
 14.0692.20 20.0cm

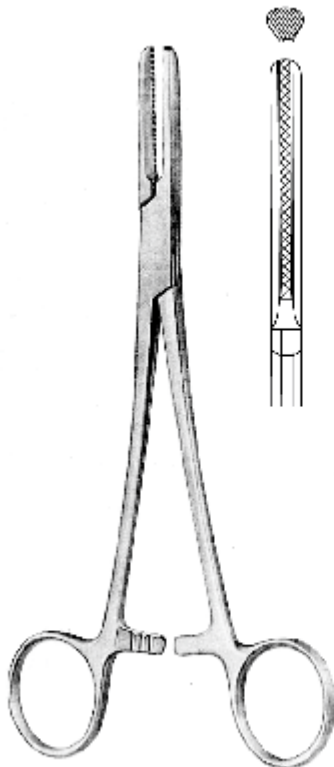

STANDARD

14.0700.15 15.0cm
 14.0700.18 18.0cm
 14.0700.20 20.0cm

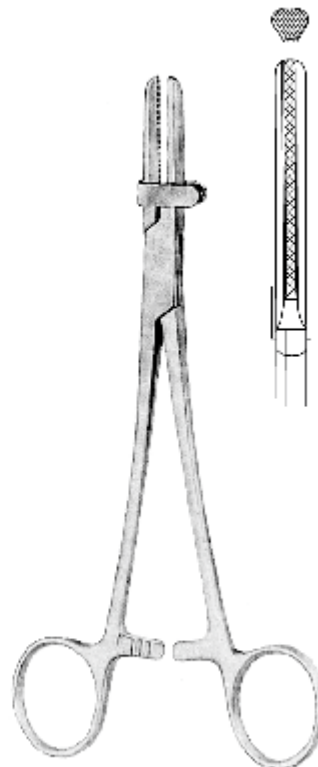

14.0702.15 15.0cm
 14.0702.16 16.5cm
 14.0702.18 18.0cm
 14.0702.20 20.0cm

ARTERY FORCEPS

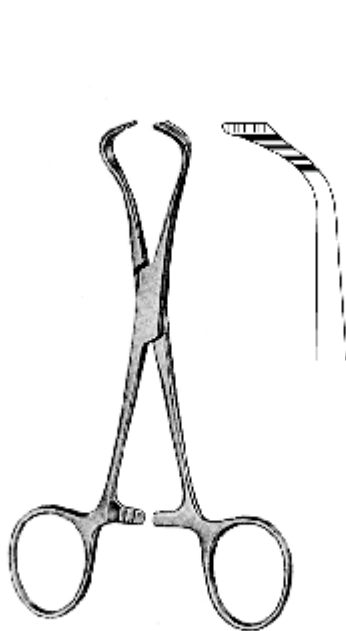

LORNA
14.0710.10 10.0cm
14.0710.13 13.0cm

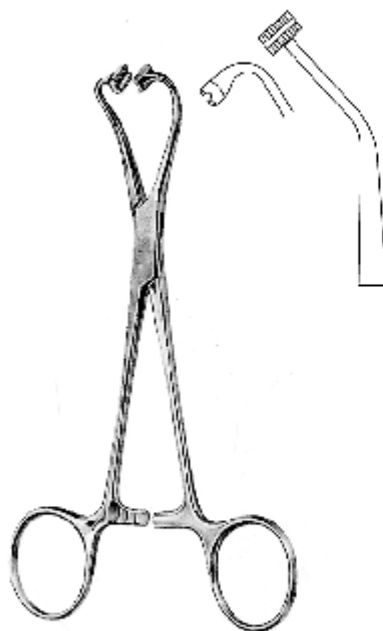

PEERS-BERTRAM
14.0714.14 14.5cm

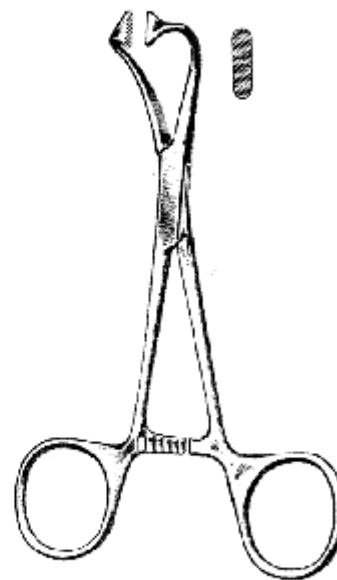

14.0718.10 10.0cm
14.0718.13 13.0cm

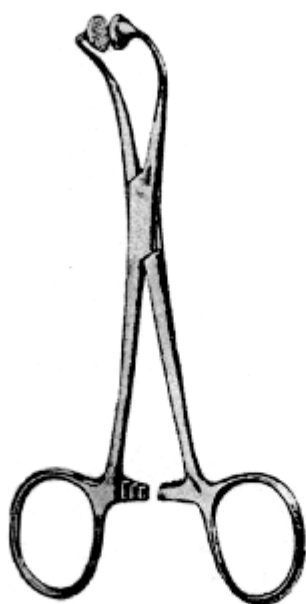

HOFF (HOFER)
14.0720.10 10.0cm
14.0720.14 14.5cm

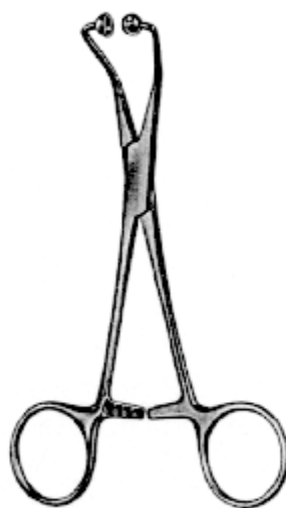

BALL AND SOCKET
14.0722.13 13.0cm

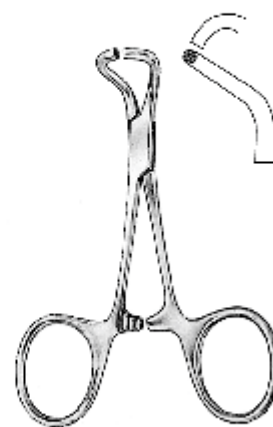

TOHOKU
14.0726.10 10.0cm
14.0726.13 13.0cm

Towel Clamps
 Tuchklemmen
 Pinzas para compresas, pinzas de campo
 Зажимы для операционного белья
 毛巾夹



SCHAEDEL
 14.0730.09 9.0cm



ENGLISH MODEL
 14.0732.09 9.0cm



JONES
 14.0734.05 5.0cm
 14.0734.09 9.0cm



JONES
 14.0736.09 9.0cm

ARTERY FORCEPS

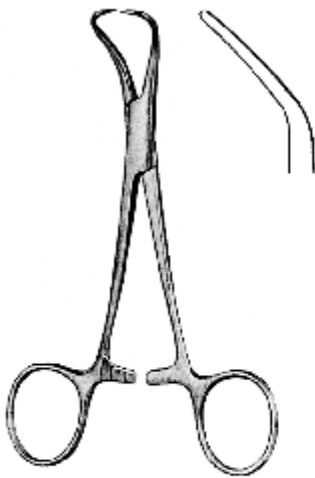

BACKHAUS
 14.0740.08 08.0cm
 14.0740.09 09.0cm
 14.0740.11 11.0cm
 14.0740.13 13.0cm
 14.0740.14 14.0cm
 14.0740.15 15.0cm



DELICATE
 14.0742.11 11.0cm
 14.0742.13 13.0cm



14.0746.11 11.0cm

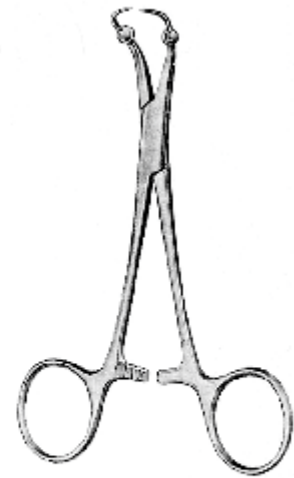

ROEDER
 14.0750.13 13.0cm
 14.0750.15 15.0cm



ROBIN
14.0754.13 13.5cm



ROBIN
14.0756.13 13.5cm



BERNHARD
14.0758.16 16.5cm

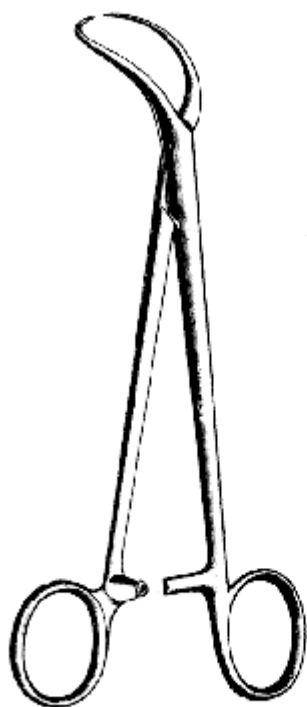

MAYO
14.0760.14 14.0cm

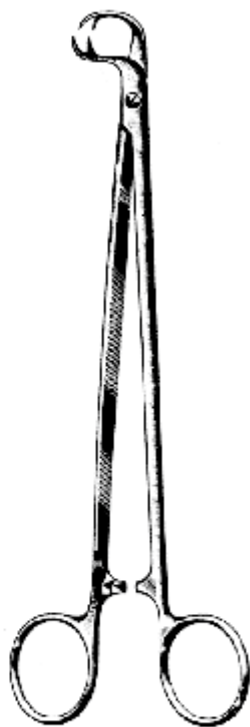

MOYNIHAN
14.0762.19 19.0cm



MOYNIHAN
14.0764.18 18.0cm



DOYEN
14.0766.18 18.0cm