



THE ULTIMATE CHOICE

## **BONE SURGERY**

Bone Surgery  
Kochenchirurgie  
Cirugia ósea  
КОСТНАЯ ХИРУРГИЯ  
骨骼手术



Amputating and Resection Saws  
 Amputations-und-Resektionssagen  
 Sierras para amputacion y reseccion  
 Пилы ампутационные, Пилы резекционные  
 骨锯



**CHARRIERE**  
 26.0010.27 27.0cm  
 26.0010.30 30.0cm  
 26.0010.34 34.0cm



**SATTERLEE**  
 26.0014.29 29.0cm  
 26.0014.31 31.0cm



**CHARRIERE**  
 26.0020.27 27.0cm  
 26.0020.30 30.0cm



**SATTERLEE**  
 26.0024.31  
 31.0cm



26.0030.23  
 23.0cm



26.0034.19  
 19.0cm

BONE SURGERY



**SPARE SAW BLADE**  
 26.0040.12 12mm  
 26.0040.15 15mm  
 26.0040.18 18mm



**CHAARRIERE**  
 26.0040.35 35.0cm



**SPARE SAW BLADE**  
 26.0044.03 3mm  
 26.0044.05 5mm  
 26.0044.07 7mm



**HELFERICH-BIER**  
 26.0044.39 39.0cm



**LINDEMANN**  
 26.0050.20 20.0cm



**LANGENBECK**  
 26.0054.23 23.0cm

26.0060.06 6mm  
 26.0060.08 8mm  
 26.0060.12 12mm  
 26.0060.15 15mm  
 26.0060.18 18mm

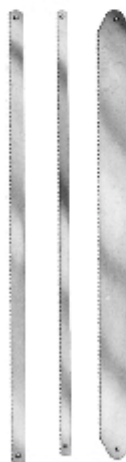

**RUST**  
 26.0060.39 39.0cm





**STILLE-SHERMAN**  
 24.0cm  
 26.0070.00 compl. set  
 26.0070.24 drill only



26.0072.25 2.5mm Ø  
 26.0072.30 3.0mm Ø  
 26.0072.35 3.5mm Ø

BONE SURGERY



**HUDSON**  
 26.0074.00 compl. set / 6  
 (26.0074.27,01,  
 02,03,07,09)  
 26.0074.27 handle only



26.0076.01  
 9mm Ø



26.0076.02  
 14mm Ø



26.0076.03  
 16mm Ø



26.0076.04  
 22mm Ø



**CUSHING**  
 26.0076.05  
 14mm Ø



26.0076.06  
 2mm Ø



**MCKENZIE**  
 26.0076.07  
 13mm Ø



**ERRICO**  
 26.0076.08  
 16mm Ø



26.0076.09



**STILLE**  
20.0cm  
26.0080.00 compl. set  
26.0080.20 drill only

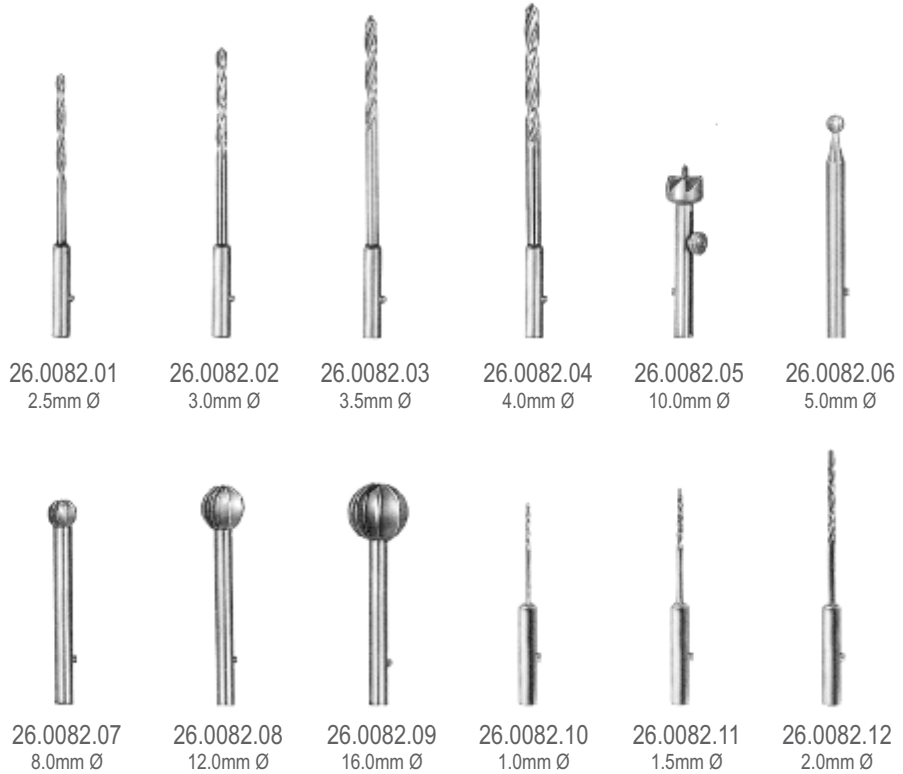

26.0082.01 2.5mm Ø	26.0082.02 3.0mm Ø	26.0082.03 3.5mm Ø	26.0082.04 4.0mm Ø	26.0082.05 10.0mm Ø	26.0082.06 5.0mm Ø
26.0082.07 8.0mm Ø	26.0082.08 12.0mm Ø	26.0082.09 16.0mm Ø	26.0082.10 1.0mm Ø	26.0082.11 1.5mm Ø	26.0082.12 2.0mm Ø



26.0084.00 compl. set  
26.0084.01 drill only



26.0084.09 9.0cm  
3.2mm Ø

26.0084.07 7.0cm  
3.2mm Ø

26.0084.08 set  
Set of drills



**JACOBS**  
26.0090.00 6.35mm



26.0092.00 set  
26.0092.01 key



26.0094.00 set  
26.0094.01 key



**BUNNELL**  
26.0100.00



**RALK**  
26.0104.00



**RALK-UNIVERSAL**  
26.0108.00 Left hand  
26.0110.00 Right hand

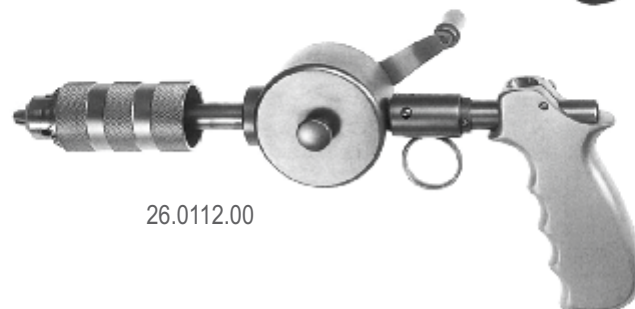

26.0112.00

BONE SURGERY

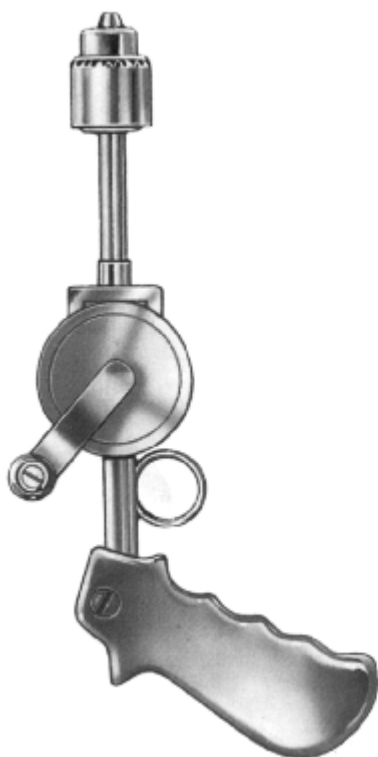

26.0116.00



26.0120.00



26.0122.00



26.0124.01

26.0124.00 complete set



26.0128.01

26.0128.02



26.0128.03

**KIRSCHNER**  
26.0128.00 complete set

Bone Plate Wrench and Screw and Plate Holding Forceps  
 Knochenplatten-Biegehebel-schrauben und platten Haltezaugen  
 Elevador p/plegar las placas y pinzas porta-tornillos placas  
 Отвертки  
 持钉钳、持板钳、钢板弯曲扳手

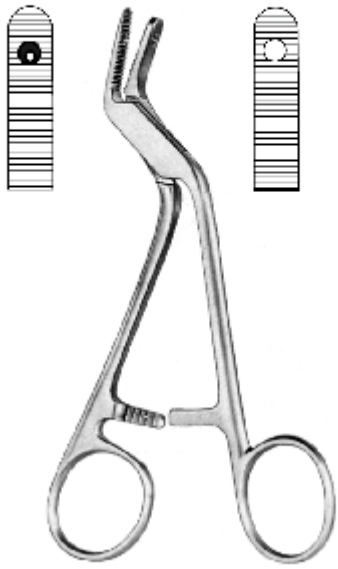

**ADSON**  
 26.0130.15  
 15.0cm



**ADSON**  
 26.0134.18  
 18.0cm



**LANE**  
 26.0140.22  
 22.0cm

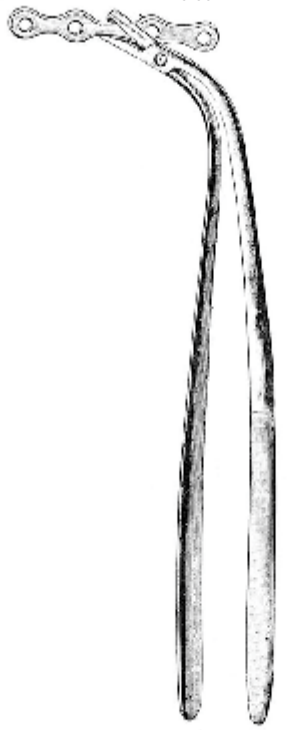

**LANE**  
 26.0144.22  
 22.0cm



**LANE**  
 26.0150.18  
 18.0cm



26.0154.25  
 25.5cm

BONE SURGERY

BONE SURGERY

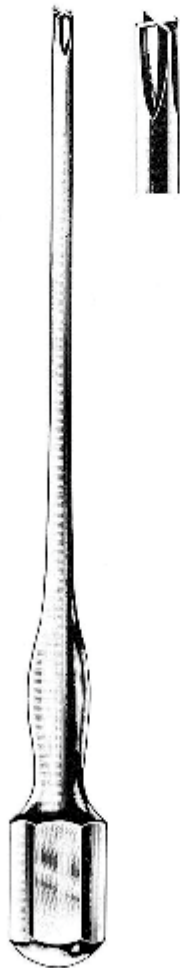

26.0160.25 25.0cm

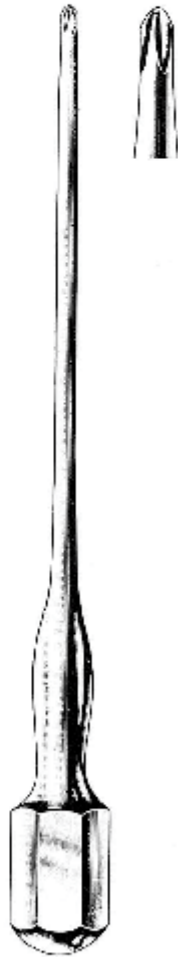

**PHILLIPS**  
26.0164.25 25.0cm



**LANE**  
26.0170.17 17.0cm  
26.0170.25 25.0cm



**WILLIAMS**  
26.0174.24 24.0cm – flat  
26.0176.24 24.0cm + cross slot

Screw Drivers  
Schraubenzieher  
Destornilladores  
Отвертки  
起子 (螺丝刀)



26.0180.25 2.5mm  
26.0180.35 3.5mm  
26.0180.45 4.5mm  
25.0cm



**PHILLIPS**  
26.0184.25 25.0cm



26.0190.25 25.0cm



**LANE**  
26.0194.17 17.0cm  
26.0194.25 25.0cm

BONE SURGERY

Screw Driver set in case  
 Schraubenzicher-set mit-Etui  
 Juego de destornilladores en esuche  
 Отвертки, Коробки для инструментов  
 螺杆驱动程序设置案例

BONE SURGERY



1/2  
 26.0200.14 14.5cm



1/4  
 26.0200.13



26.0200.00 Screw driver set, complete in case  
 26.0200.01 Sterilizing case only



1/4  
 26.0200.02

-



1/4  
 26.0200.03

+



1/4  
 26.0200.04

+



1/4  
 26.0200.05

+

2.5mm



1/4  
 26.0200.06  
 26.0200.07

3.5mm

+

Nail Driver and Reamers  
 Nageln Sie Fahrer und Reibahlen  
 Clave a conductores y escariadores  
 Развертки, Римеры  
 钉驱动器 and 铰刀



26.0210.24  
2.4mm



26.0210.32  
3.2mm



26.0210.48  
4.8mm



26.0210.64  
6.4mm



26.0220.14 14.0cm



26.0222.14 14.0cm



**PERTHES**  
26.0224.21 21.0mm

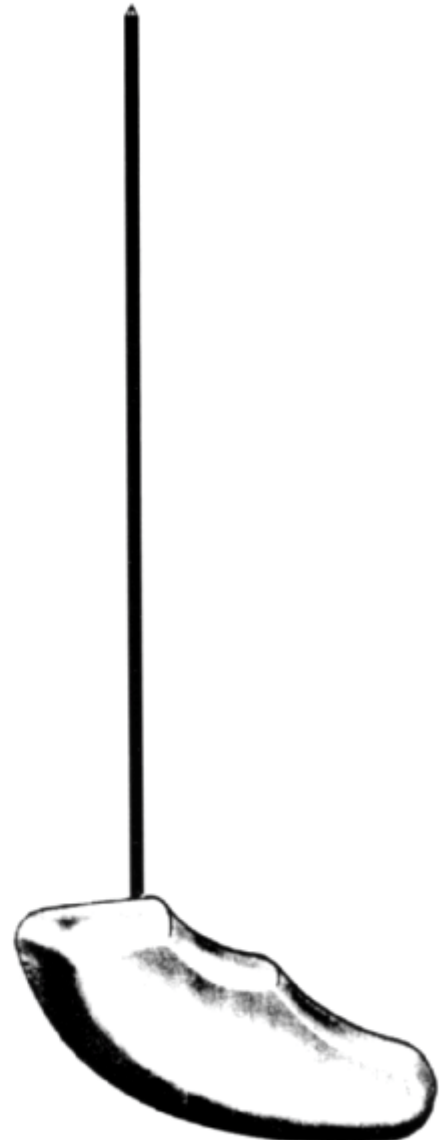

26.0226.24 2.4mm  
 26.0226.32 3.2mm  
 26.0226.48 4.8mm  
 26.0226.64 6.4mm

BONE SURGERY



26.0230.16 16.5cm

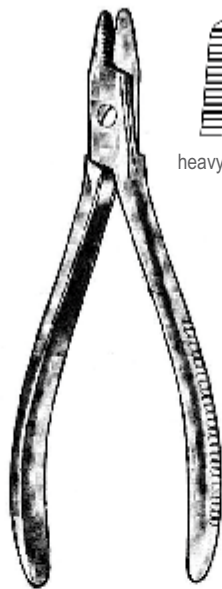

heavy pattern

26.0232.16 16.0cm



26.0236.15 15.0cm

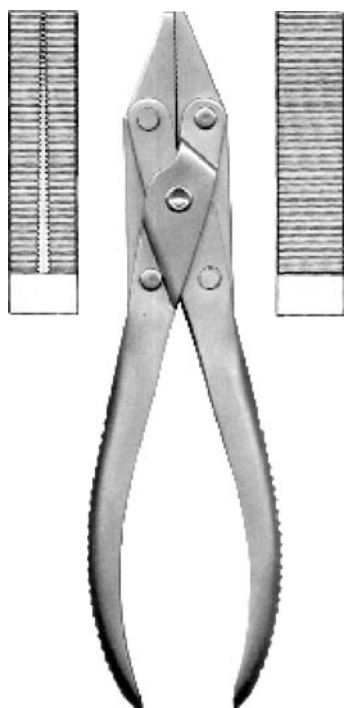

26.0240.17 18.5cm

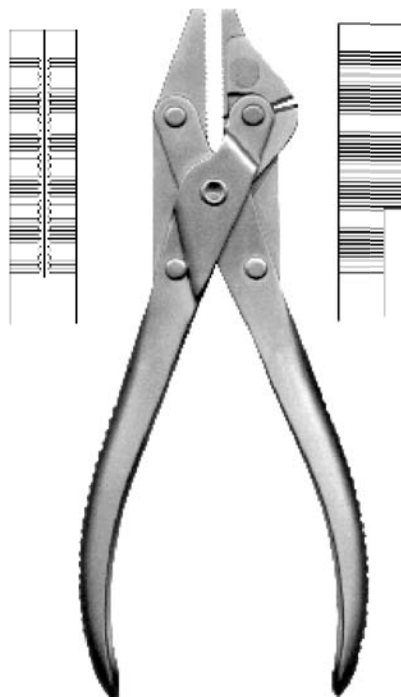

26.0242.18 18.0cm



26.0244.18 18.0cm

Flat Nose Pliers  
 Flachzangen  
 Alicates planas  
 Плоскогубцы для костной хирургии  
 扁嘴钳

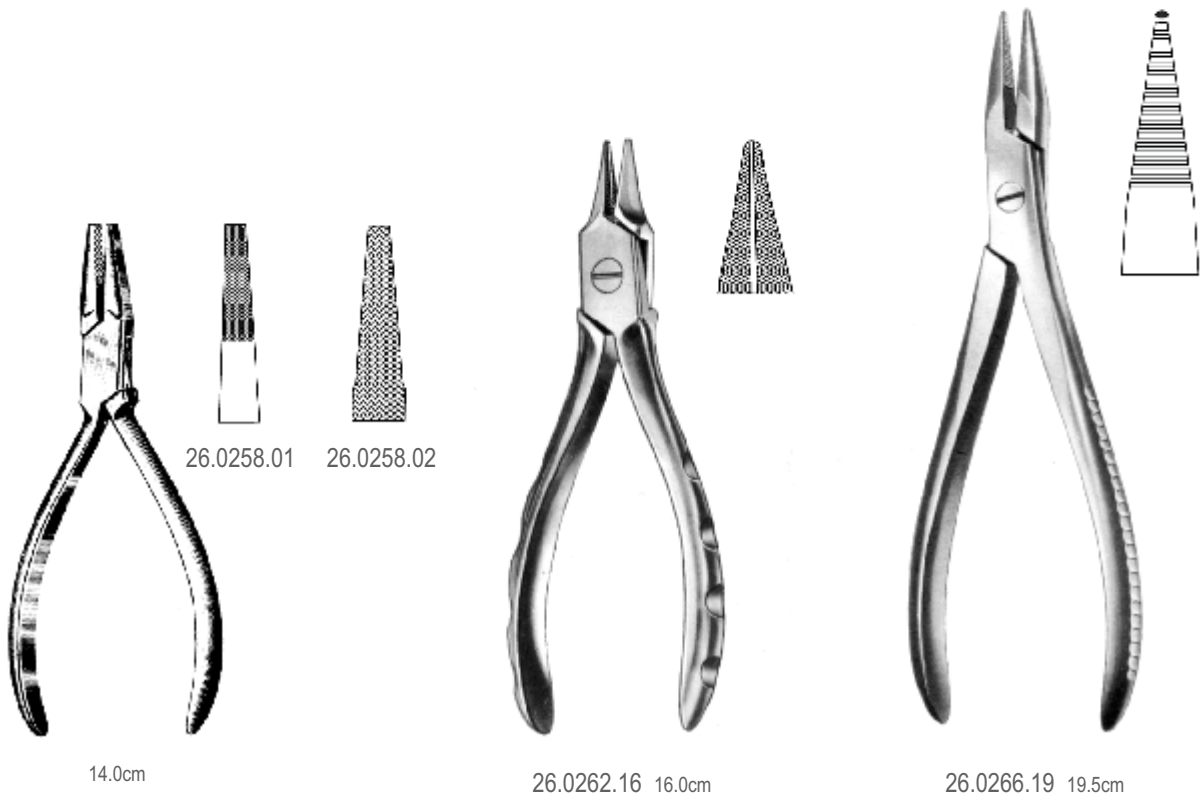
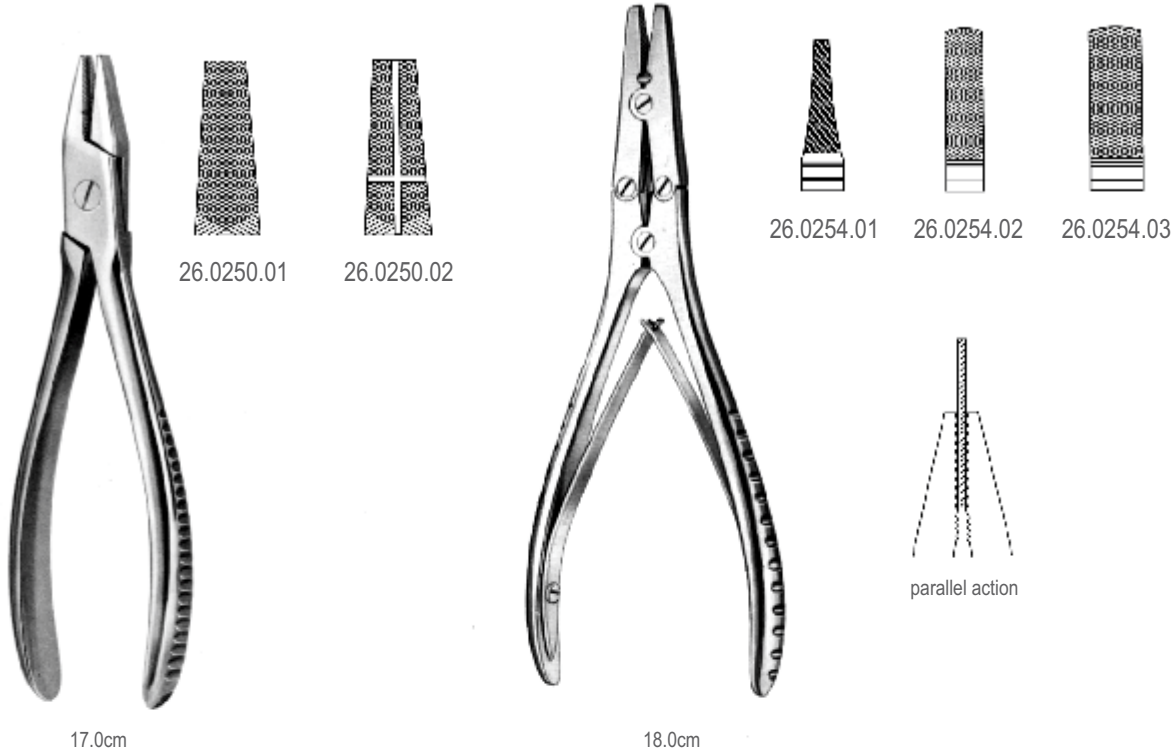

BONE SURGERY



**PARHAM**

26.0270.18 18.0cm  
 26.0270.20 20.0cm  
 26.0270.25 25.0cm  
 26.0270.30 30.0cm



**PARHAM**

26.0274.22 22.0cm

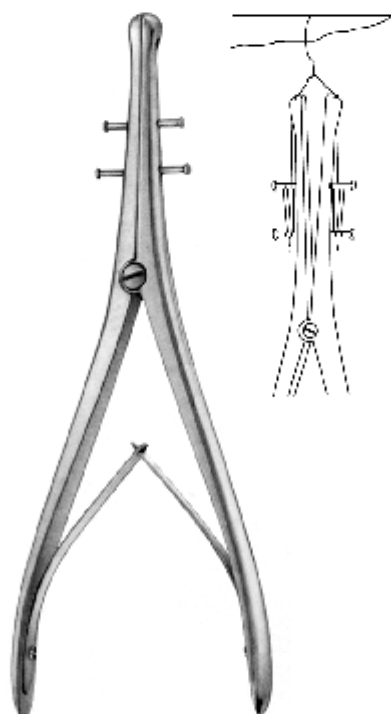

**DEMEL**

26.0280.28 28.0cm

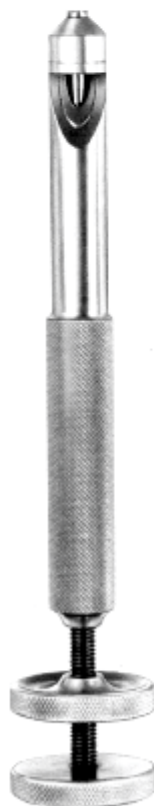

**LOUTE**

26.0284.21 21.0cm

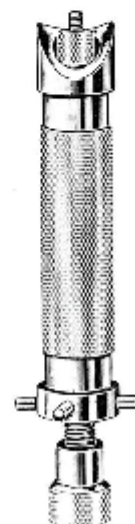

**LLOYD**

26.0288.00

Bone Wire, Bone Wire Guides  
Cerclage-Draht, Drahtumfuhrungsnadeln

Hilo para huesos, agujas pasa-hilos

Иглы направляющие для проволоки, Проволока для скрепления костей

钢丝、钢丝导引器



	soft	hard
0.2mm Ø	26.0290.02	
0.3mm Ø	26.0290.03	26.0292.03
0.4mm Ø	26.0290.04	26.0292.04
0.5mm Ø	26.0290.05	
0.6mm Ø	26.0290.06	26.0292.06
0.7mm Ø	26.0290.07	
0.8mm Ø	26.0290.08	26.0292.08
0.9mm Ø	26.0290.09	
1.0mm Ø	26.0290.10	26.0292.10
1.2mm Ø	26.0290.12	
1.5mm Ø	26.0290.15	

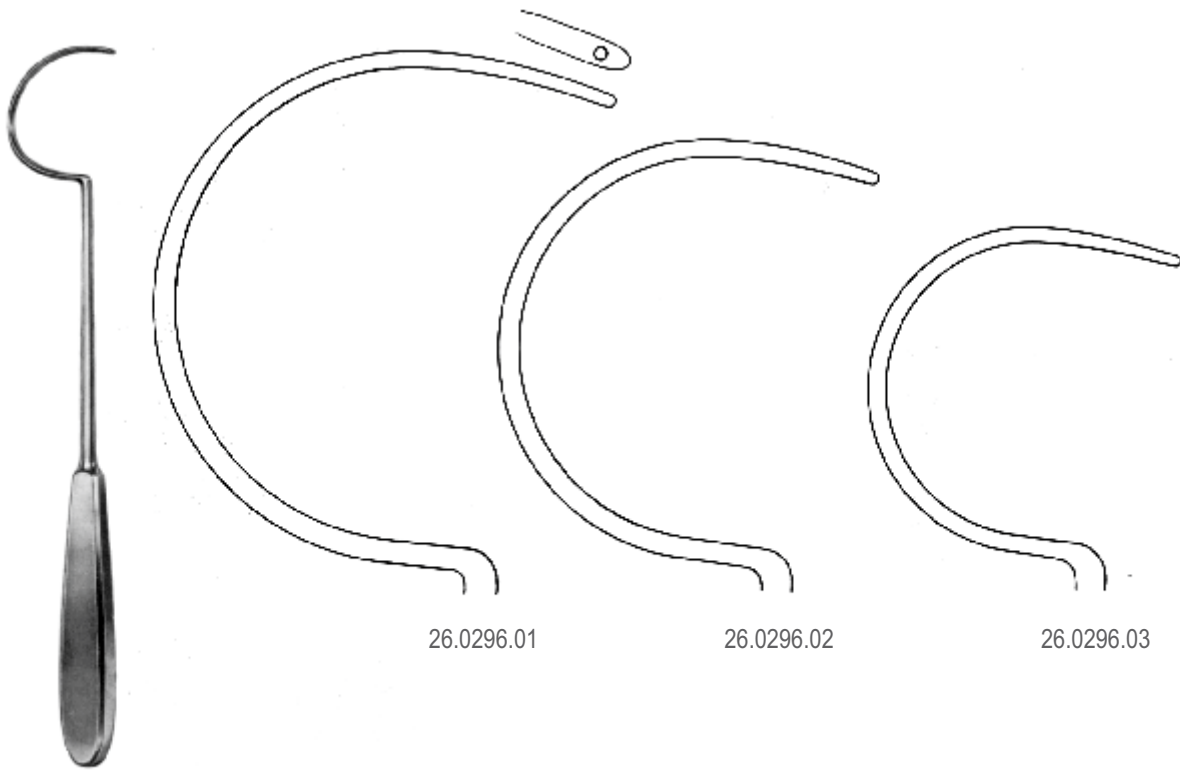

26.0296.01

26.0296.02

26.0296.03

DEMEL

BONE SURGERY

BONE SURGERY



**KUENTSCHER**  
26.0304.21 21.0cm

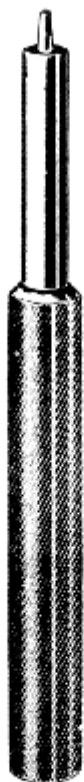

**KUENTSCHER**  
26.0306.21 21.0cm



**KUENTSCHER**  
26.0310.00 63.0cm  
complete set



26.0310.01 26.0310.02

26.0310.03 26.0310.04

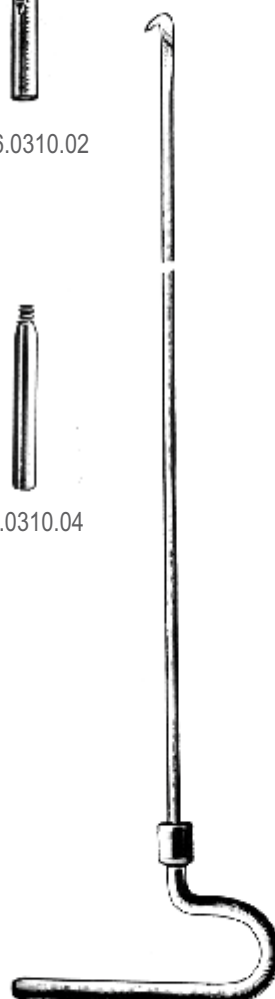

26.0314.29 29.0cm  
26.0314.37 37.0cm  
26.0314.42 42.0cm  
26.0314.49 49.0cm

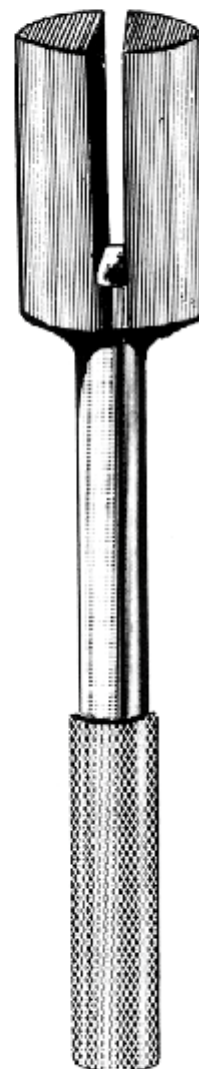

26.0320.00

Bone Nailing, Steinmann Pins  
 Knochennagelung, Steinmann Nagel  
 Enclavamiento de huesos, calvos segun steinmann  
 Спицы, Римеры  
 骨科钢针

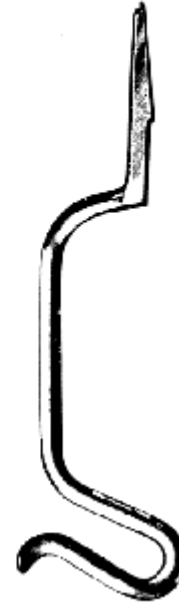

	L=35cm	L=46cm	L=60cm
2.5mm Ø	26.0330.25	26.0332.25	
3.0mm Ø	26.0330.30	26.0332.30	
3.5mm Ø	26.0330.35	26.0332.35	26.0334.35
4.0mm Ø	26.0330.40	26.0332.40	26.0334.40
5.0mm Ø	26.0330.50	26.0332.50	26.0334.50

**KUENTSCHER**  
 26.0340.26 26.0cm

**KUENTSCHER**  
 26.0344.35 35.0cm



**STEINMANN**  
 4mm Ø (Trocar tip)  
 26.0360.14 140mm  
 26.0360.16 160mm  
 26.0360.18 180mm  
 26.0360.20 200mm

**SCHANZ**  
 4mm Ø (Flat tip)  
 26.0364.06 60mm  
 26.0364.08 80mm  
 26.0364.10 100mm

**SCHANZ**  
 6mm Ø (Flat tip)  
 26.0366.10 100mm  
 26.0366.13 130mm  
 26.0366.16 160mm  
 26.0366.19 190mm

**SCHANZ**  
 5mm Ø (Trocar tip)  
 26.0368.10 100mm  
 26.0368.12 125mm  
 26.0368.15 150mm  
 26.0368.17 170mm  
 26.0368.20 200mm  
 26.0368.25 250mm

BONE SURGERY

**KIRSCHNER**

trocar point  
flat end



mm ø	60 mm	120mm	140mm	160mm	310mm
0.6	26.0380.06				
0.8	26.0380.08				
1.0	26.0380.10	26.0382.10	26.0384.10	26.0386.10	26.0388.10
1.2	26.0380.12	26.0382.12	26.0384.12	26.0386.12	26.0388.12
1.4	26.0380.14	26.0382.14	26.0384.14	26.0386.14	26.0388.14
1.5	26.0380.15	26.0382.15	26.0384.15	26.0386.15	26.0388.15
1.6	26.0380.16	26.0382.16	26.0384.16	26.0386.16	26.0388.16
1.8	26.0380.18	26.0382.18	26.0384.18	26.0386.18	26.0388.18
2.0	26.0380.20	26.0382.20	26.0384.20	26.0386.20	26.0388.20
2.2	26.0380.22	26.0382.22	26.0384.22	26.0386.22	26.0388.22
2.5	26.0380.25	26.0382.25	26.0384.25	26.0386.25	26.0388.25

**KIRSCHNER**

trocar point  
round end



mm ø	60 mm	120mm	140mm	160mm	310mm
1.0	26.0390.10	26.0392.10	26.0394.10	26.0396.10	26.0398.10
1.2	26.0390.12	26.0392.12	26.0394.12	26.0396.12	26.0398.12
1.4	26.0390.14	26.0392.14	26.0394.14	26.0396.14	26.0398.14
1.5	26.0390.15	26.0392.15	26.0394.15	26.0396.15	26.0398.15
1.6	26.0390.16	26.0392.16	26.0394.16	26.0396.16	26.0398.16
1.8	26.0390.18	26.0392.18	26.0394.18	26.0396.18	26.0398.18
2.0	26.0390.20	26.0392.20	26.0394.20	26.0396.20	26.0398.20
2.2	26.0390.22	26.0392.22	26.0394.22	26.0396.22	26.0398.22
2.5	26.0390.25	26.0392.25	26.0394.25	26.0396.25	26.0398.25

**KIRSCHNER**

lancet point  
flat end



mm ø	100 mm
1.0	26.0400.10
1.2	26.0400.12
1.5	26.0400.15
1.6	26.0400.16
1.8	26.0400.18
2.0	26.0400.20
2.2	26.0400.22
2.5	26.0400.25

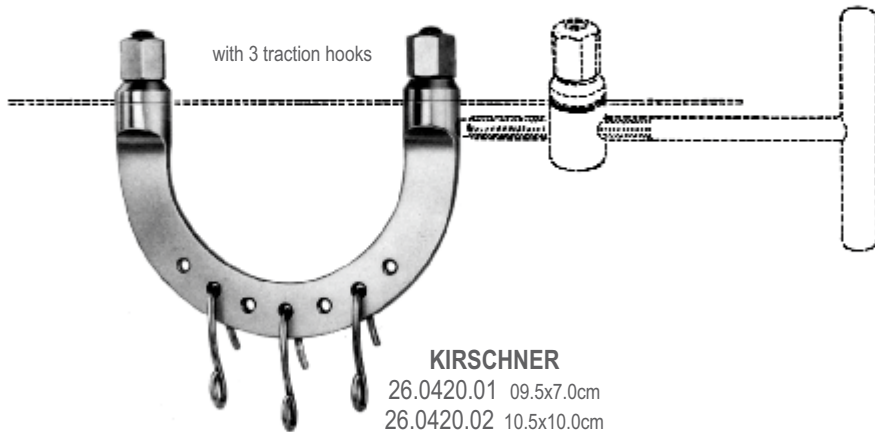

**KIRSCHNER**  
 26.0420.01 09.5x7.0cm  
 26.0420.02 10.5x10.0cm  
 26.0420.03 12.0x12.0cm  
 26.0420.04 15.5x15.5cm  
 26.0420.05 20.0x15.5cm



**KIRSCHNER**  
 26.0424.01 6.0x6.0cm

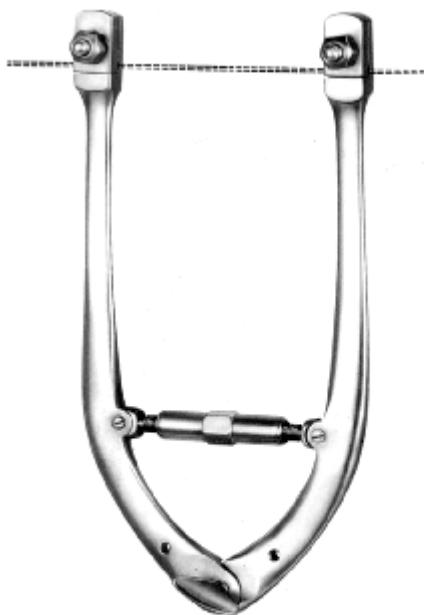

26.0430.18 18.0x10.0cm  
 26.0430.27 27.0x27.0cm

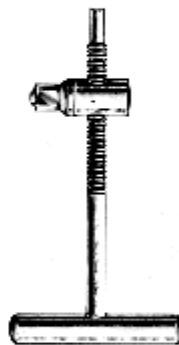

26.0434.18



26.0440.19 19.0cm



26.0444.03

26.0444.06

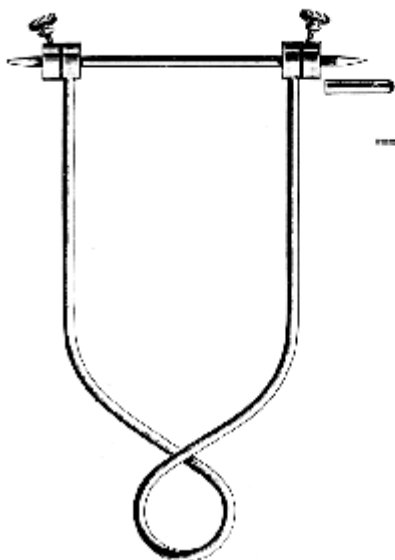

**BÖHLER**

26.0450.15 21.0x15.0cm  
 26.0450.16 16.0x 9.0cm  
 26.0450.21 21.0x11.0cm



**KIRSCHNER**

26.0454.01 13.5cm, infant  
 26.0454.02 18.5cm, child  
 26.0454.03 27.0cm, adult



**MARTIN-DIAMANT**

26.0460.16  
 16.0cm



26.0464.16  
 16.0cm



26.0470.15  
 15.0cm



26.0474.23  
 23.0cm



26.0474.25  
 25.0cm



26.0480.24  
 24.0cm