



THE ULTIMATE CHOICE

## **CARDIOVASCULAR**

Cardiovascular Surgery  
Herz-und Gefäßchirurgie  
Cirugia cardiovascular  
СЕРДЕЧНО-СОСУДИСТАЯ ХИРУРГИЯ  
心血管



Atrauma Tissue Forceps  
 Atrauma Pinzetten  
 Pinzas de diseccion atrauma  
 Пинцеты с атравматической нарезкой  
 非创伤性组织钳

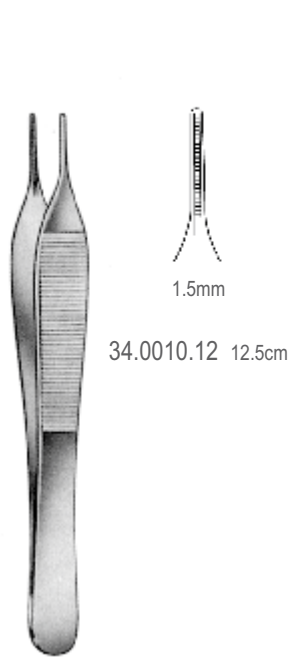

34.0010.12 12.5cm

DEBAKEY-ADSON



34.0014.15 15.0cm  
 34.0014.18 18.0cm

DEBAKEY-GERALD



1.0mm

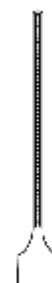

1.2mm

34.0016.15 15.0cm  
 34.0016.18 18.0cm  
 34.0016.24 24.0cm

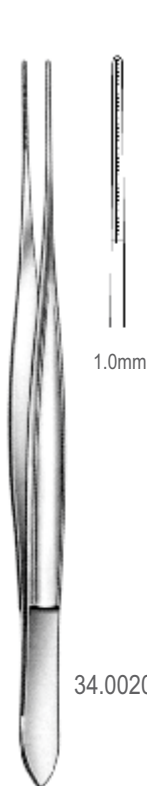

34.0020.18 18.0cm

DEBAKEY-CUSHING



1.0mm

34.0024.15 15.0cm 34.0026.15  
 34.0024.19 19.0cm 34.0026.19  
 34.0024.24 24.0cm 34.0026.24

DEBAKEY-DIETRICH



1.5mm



1.0mm

34.0030.15 15.0cm  
 34.0030.19 19.0cm  
 34.0030.24 24.0cm

DEBAKEY-LIGHT

CARDIOVASCULAR

ALSO AVAILABLE IN TITANIUM

CARDIOVASCULAR

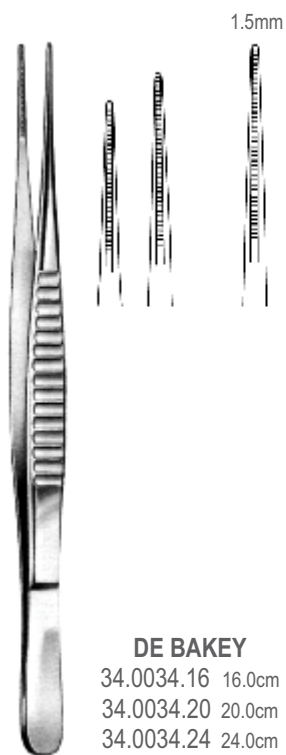

**DE BAKEY**  
34.0034.16 16.0cm  
34.0034.20 20.0cm  
34.0034.24 24.0cm  
34.0034.30 30.0cm

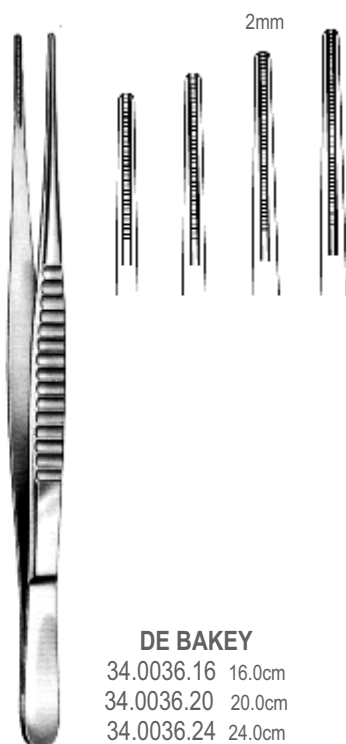

**DE BAKEY**  
34.0036.16 16.0cm  
34.0036.20 20.0cm  
34.0036.24 24.0cm  
34.0036.30 30.0cm

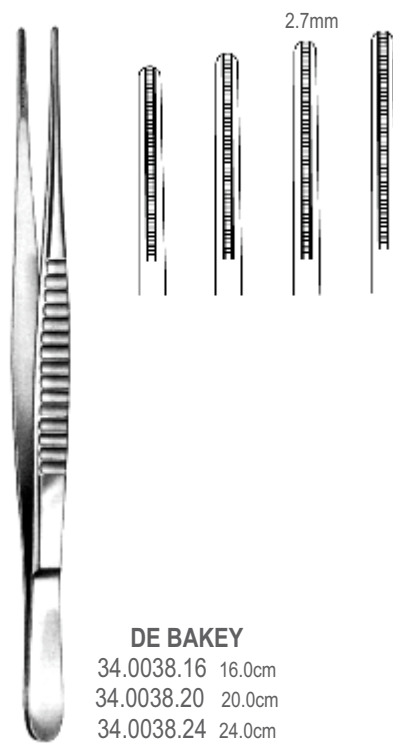

**DE BAKEY**  
34.0038.16 16.0cm  
34.0038.20 20.0cm  
34.0038.24 24.0cm  
34.0038.30 30.0cm

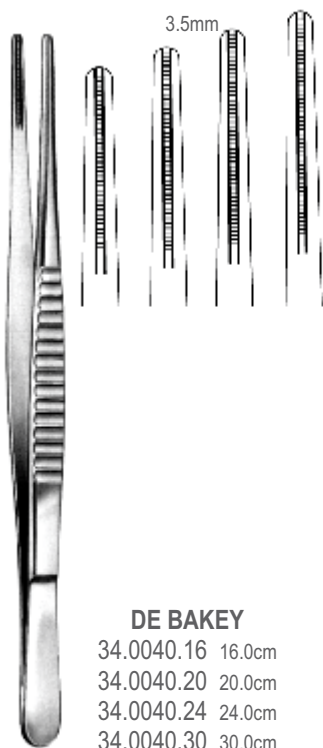

**DE BAKEY**  
34.0040.16 16.0cm  
34.0040.20 20.0cm  
34.0040.24 24.0cm  
34.0040.30 30.0cm

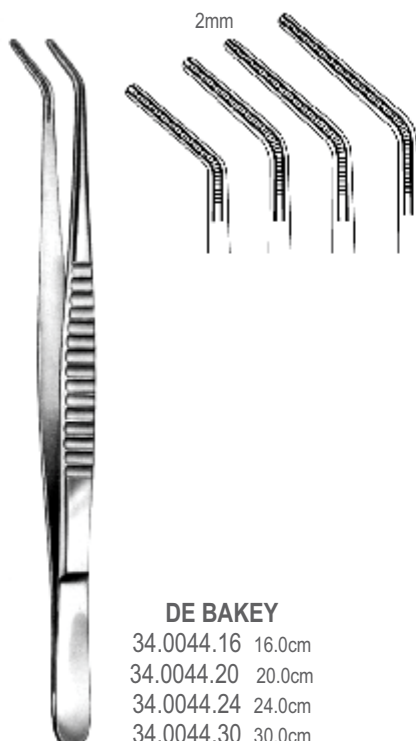

**DE BAKEY**  
34.0044.16 16.0cm  
34.0044.20 20.0cm  
34.0044.24 24.0cm  
34.0044.30 30.0cm



**DE BAKEY**  
34.0046.16 16.0cm  
34.0046.20 20.0cm  
34.0046.24 24.0cm  
34.0046.30 30.0cm

Atrauma Bulldog Clamps  
 Atrauma Bulldogklemmen  
 Atrauma clamps bulldog  
 Зажимы типа бульдог  
 非创伤性斗牛犬夹



ALSO AVAILABLE IN TITANIUM

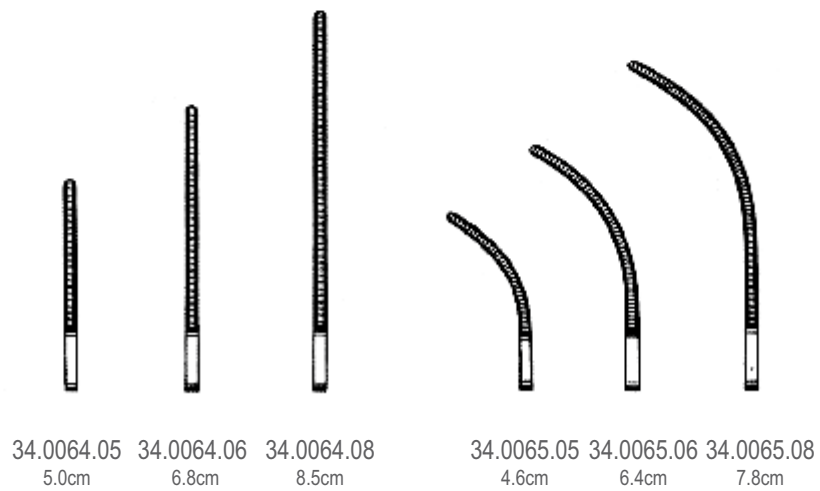
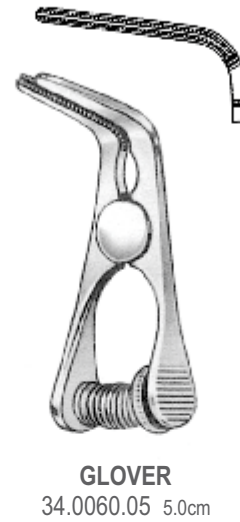

CARDIOVASCULAR

Atrauma Bulldog Clamps  
Atrauma Bulldogklemmen  
Atrauma clamps bulldog  
Зажимы типа бульдог  
非创伤性斗牛犬夹

ALSO AVAILABLE IN TITANIUM

CARDIOVASCULAR



GLOVER



34.0070.07  
7.0cm



34.0070.08  
8.0cm



34.0070.09  
9.0cm



34.0070.11  
11.0cm



GLOVER



34.0071.06  
6.0cm



34.0071.07  
7.5cm



34.0071.08  
8.5cm



34.0071.11  
10.5cm

Atrauma Bulldog Clamps  
 Atrauma Bulldogklemmen  
 Atrauma clamps bulldog  
 Зажимы типа бульдог  
 非创伤性斗牛犬夹



ALSO AVAILABLE IN TITANIUM



DE BAKEY



34.0074.07  
7.5cm



34.0074.08  
8.5cm



34.0074.10  
10.5cm



34.0074.12  
12.0cm



DE BAKEY



34.0075.07  
7.0cm

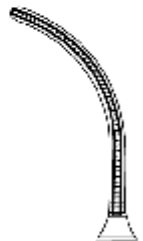

34.0075.08  
8.0cm



34.0075.10  
10.0cm

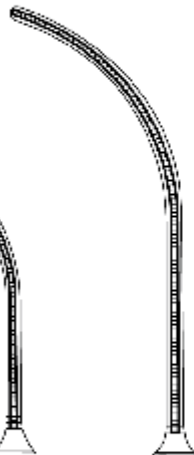

34.0075.11  
11.5cm

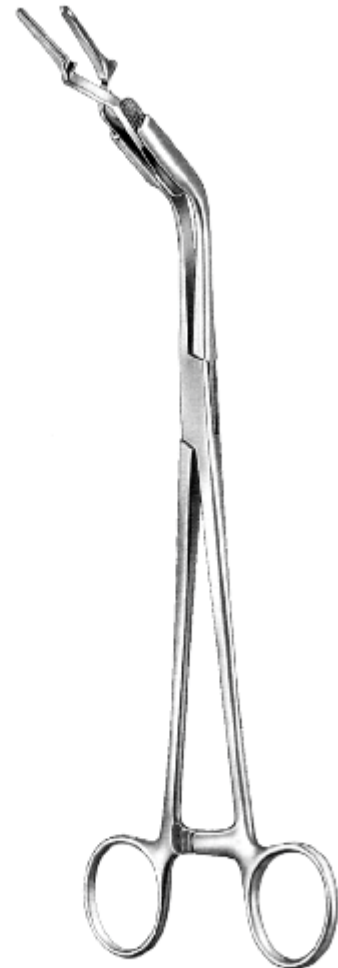

34.0080.23 23.0cm

CARDIOVASCULAR

Atrauma Bulldog Clamps  
Atrauma Bulldogklemmen  
Atrauma clamps bulldog  
Зажимы типа бульдог  
非创伤性斗牛犬夹

ALSO AVAILABLE IN TITANIUM

CARDIOVASCULAR

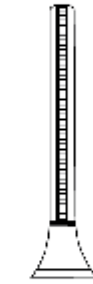

34.0084.09  
9.0cm

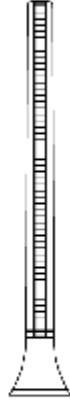

34.0084.11  
11.0cm

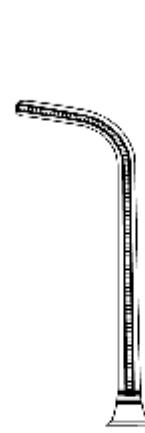

34.0085.09  
9.0cm

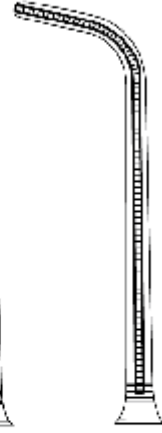

34.0085.11  
11.0cm

GREGORY SOFT

GREGORY SOFT



34.0090.01

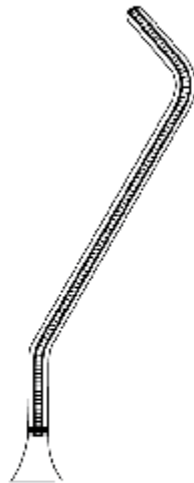

34.0090.02

GREGORY SOFT  
11.0cm



SANTULLI  
34.0094.07 7.0cm

Atrauma Bulldog Clamps  
Atrauma Bulldogklemmen  
Atrauma clamps bulldog  
Зажимы типа бульдог  
非创伤性斗牛犬夹



ALSO AVAILABLE IN TITANIUM



DE BAKY-SATINSKY  
34.0100.07 7.0cm

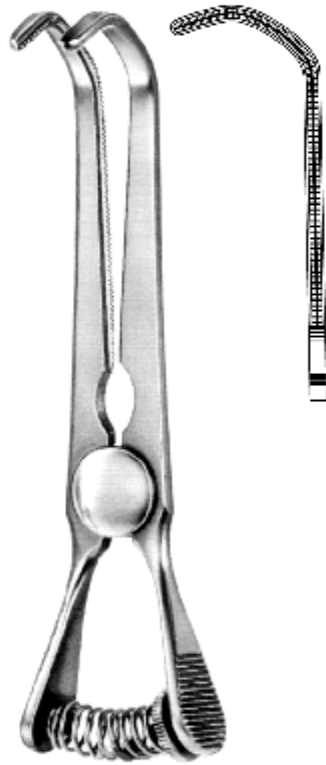

DE BAKY-SATINSKY  
34.0100.10 10.0cm



DE BAKY-CAROTIS  
34.0104.09 9.0cm

CARDIOVASCULAR

ALSO AVAILABLE IN TITANIUM

CARDIOVASCULAR

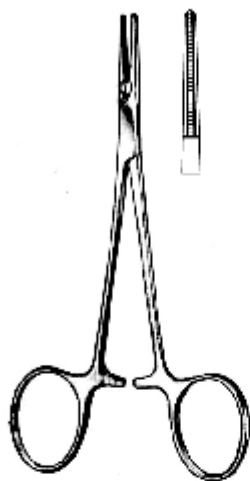

**MOSQUITO**  
34.0110.12 12.0cm



**MOSQUITO**  
34.0111.12 12.0cm

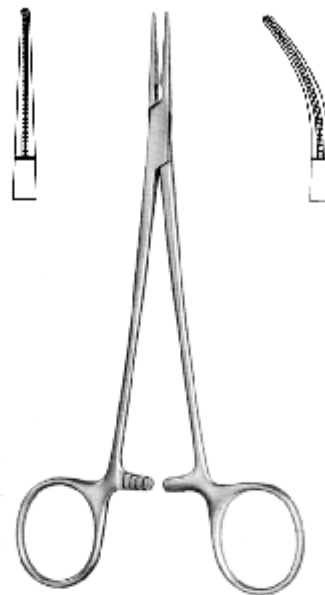

**DE BAKEY-MOSQUITO**  
34.0120.15 15.0cm 34.0121.15

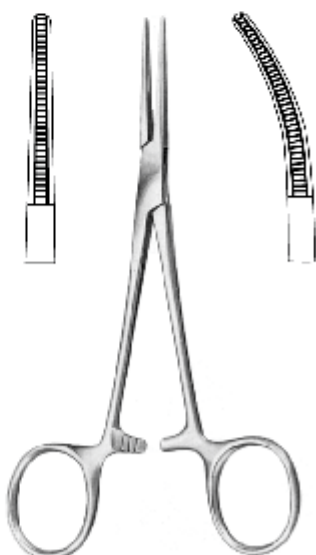

**DE BAKEY-KELLY**  
34.0124.14 14.0cm 34.0125.14

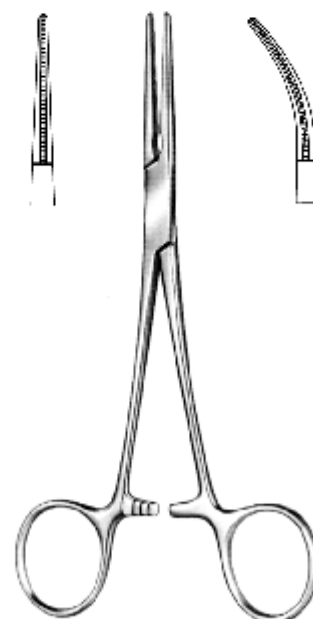

**DE BAKEY-RAKIN**  
34.0130.16 16.0cm 34.0131.16

Atrauma Cardiovascular Forceps  
Atrauma Cardiovascular-Klemmen  
Atrauma pinzas-clamps cardiovasculares  
Зажимы с атравматической нарезкой  
非创伤性心血管钳



ALSO AVAILABLE IN TITANIUM



DE BAKEY  
34.0134.10 10.0cm

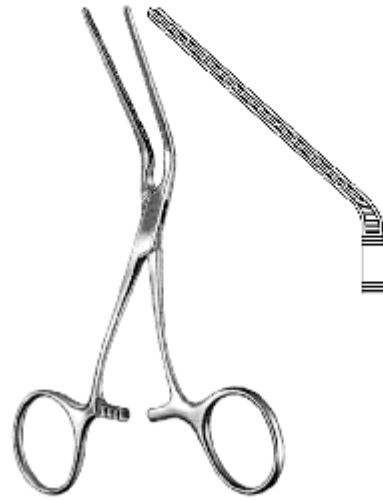

DE BAKEY  
34.0140.13 12.5cm

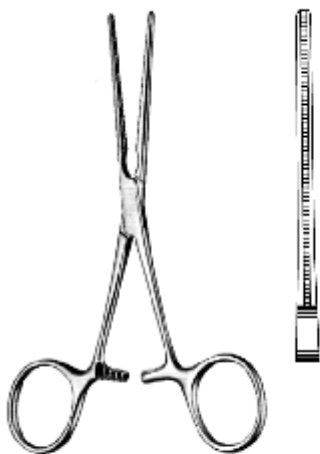

DE BAKEY  
34.0150.12 13.0cm



DE BAKEY  
34.0152.11 12.5cm

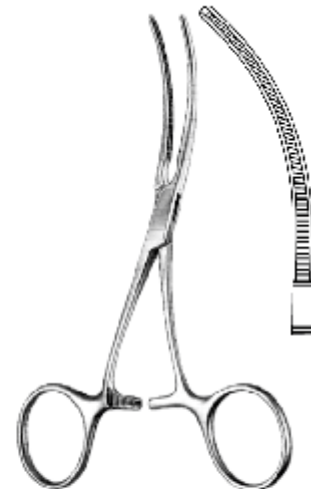

DE BAKEY  
34.0154.12 12.5cm

CARDIOVASCULAR

ALSO AVAILABLE IN TITANIUM

CARDIOVASCULAR



**HUSFELDT**  
34.0160.17 17.0cm

**HUSFELDT**  
34.0162.17 17.0cm

**HUSFELDT**  
34.0164.18 18.0cm

Atrauma Cardiovascular Forceps  
 Atrauma Cardiovascular-Klemmen  
 Atrauma pinzas-clamps cardiovasculares  
 Зажимы с атравматической нарезкой  
 非创伤性心血管钳



ALSO AVAILABLE IN TITANIUM

CARDIOVASCULAR

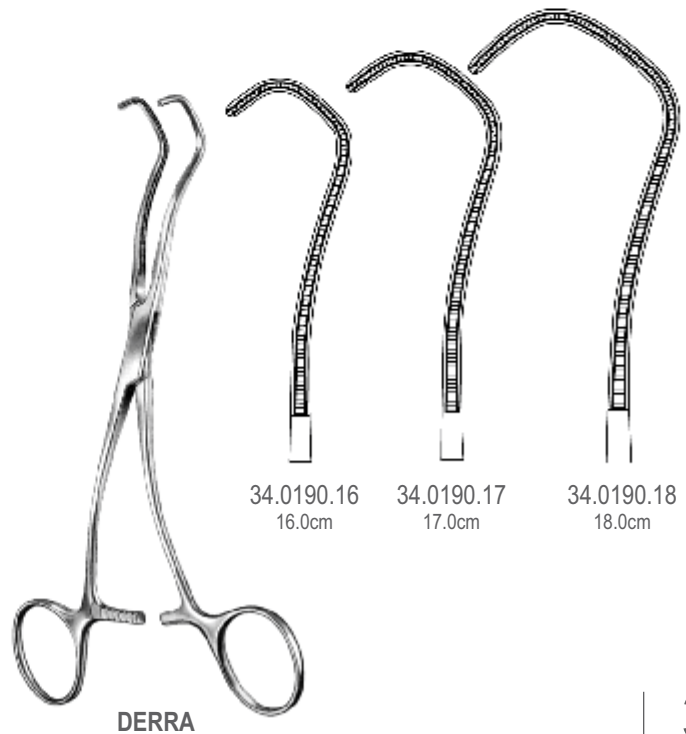
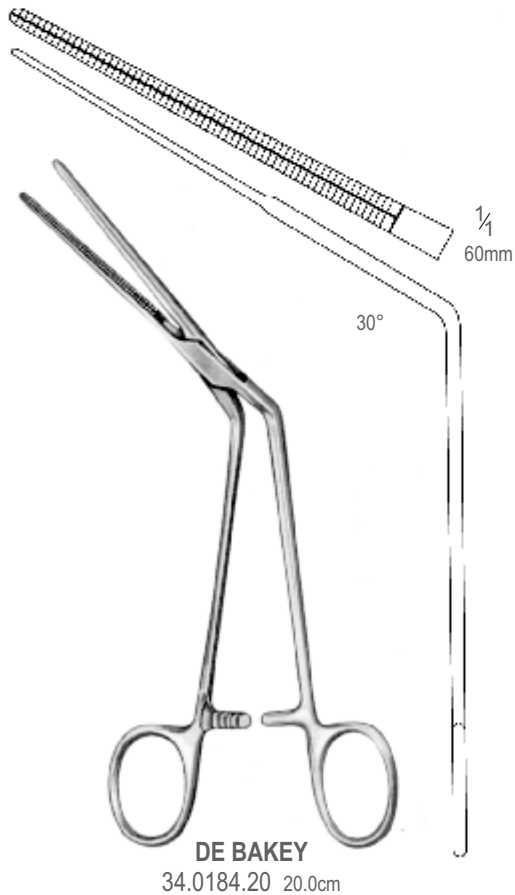
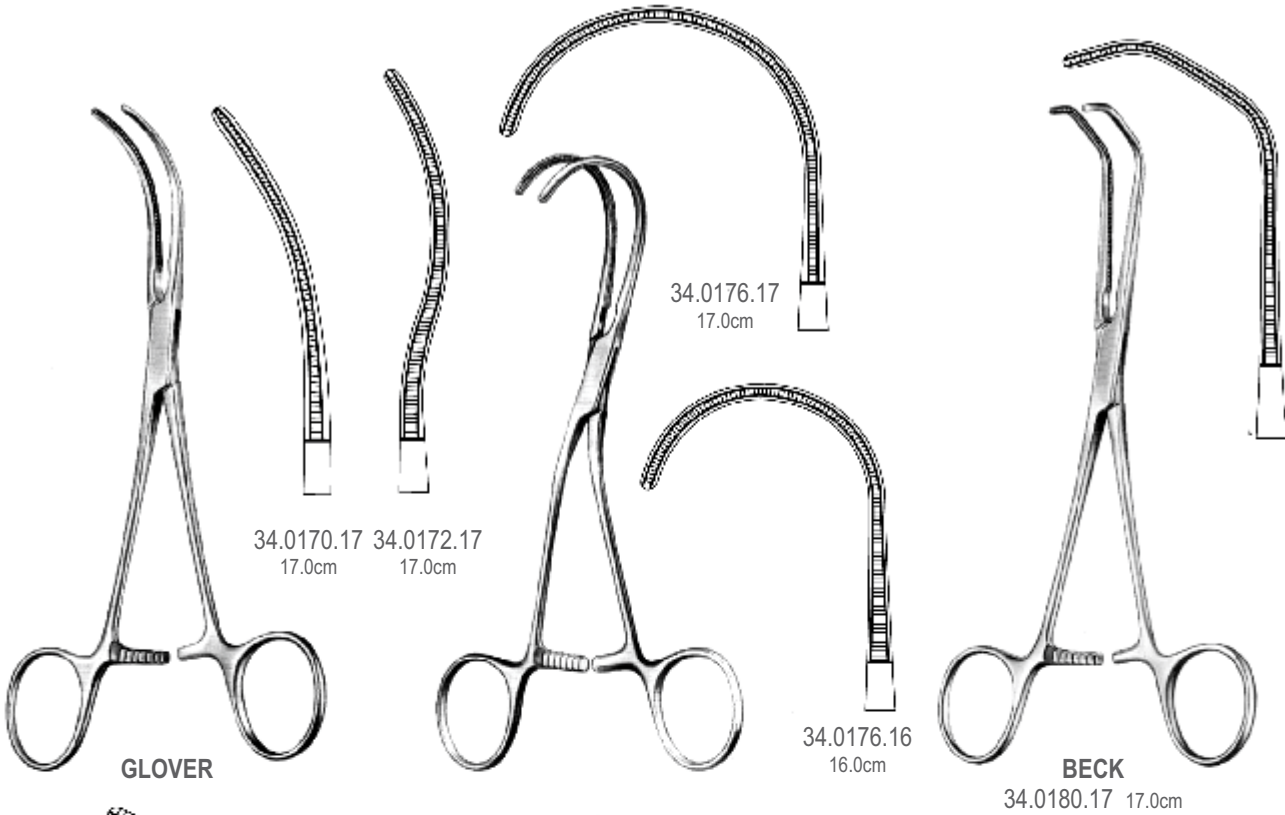

ALSO AVAILABLE IN TITANIUM

CARDIOVASCULAR

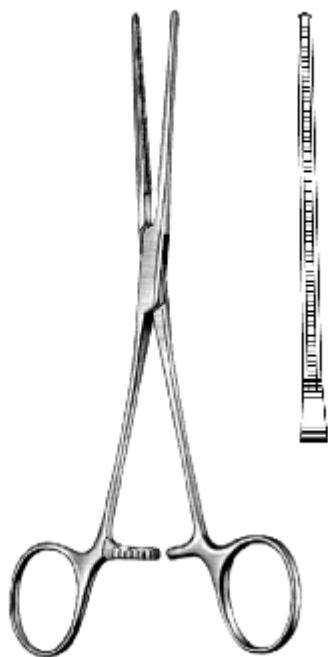

**DE BAKEY**  
34.0194.17 17.0cm

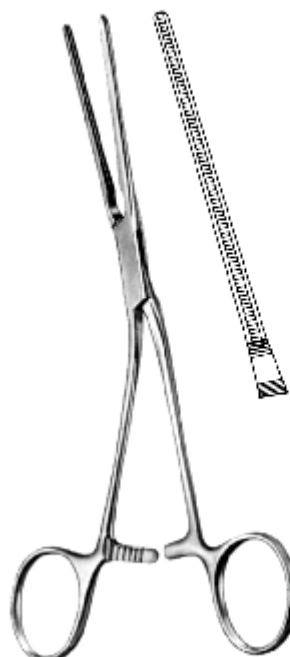

**DE BAKEY**  
34.0200.17 17.0cm

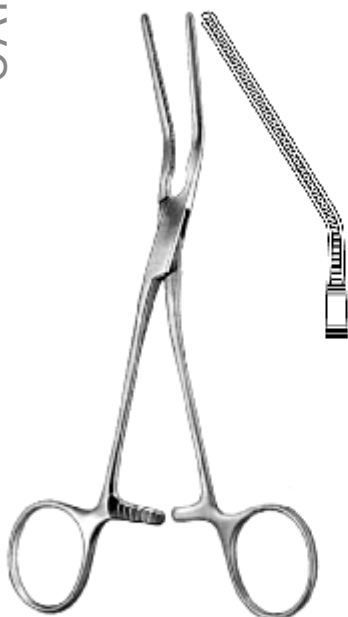

**DE BAKEY**  
34.0204.16 16.0cm

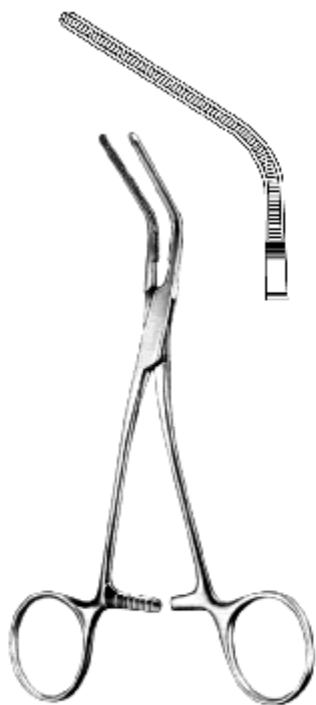

**DE BAKEY**  
34.0210.15 15.0cm

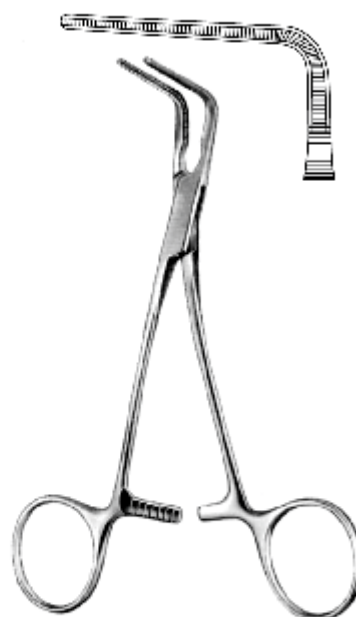

**DE BAKEY**  
34.0214.15 15.0cm

Atrauma Hemostatic Forceps  
 Atrauma Arterienklemmen  
 Atrauma hemostaticas pinzas  
 Зажимы с атравматической нарезкой  
 非创伤性止血钳



ALSO AVAILABLE IN TITANIUM



DE BAKEY-PEAN

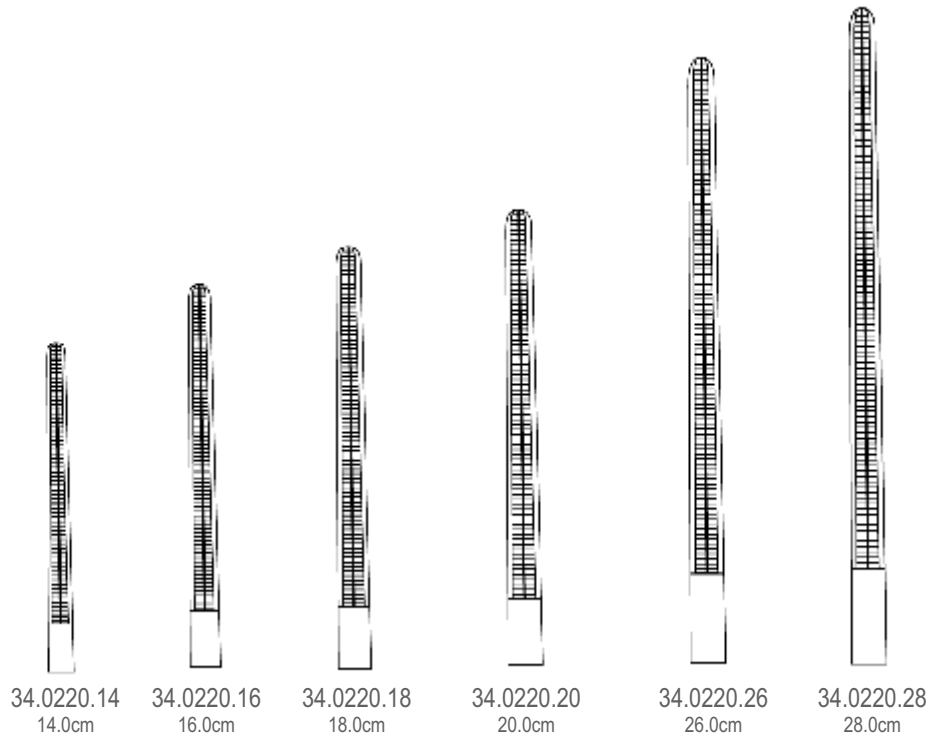

DE BAKEY-PEAN

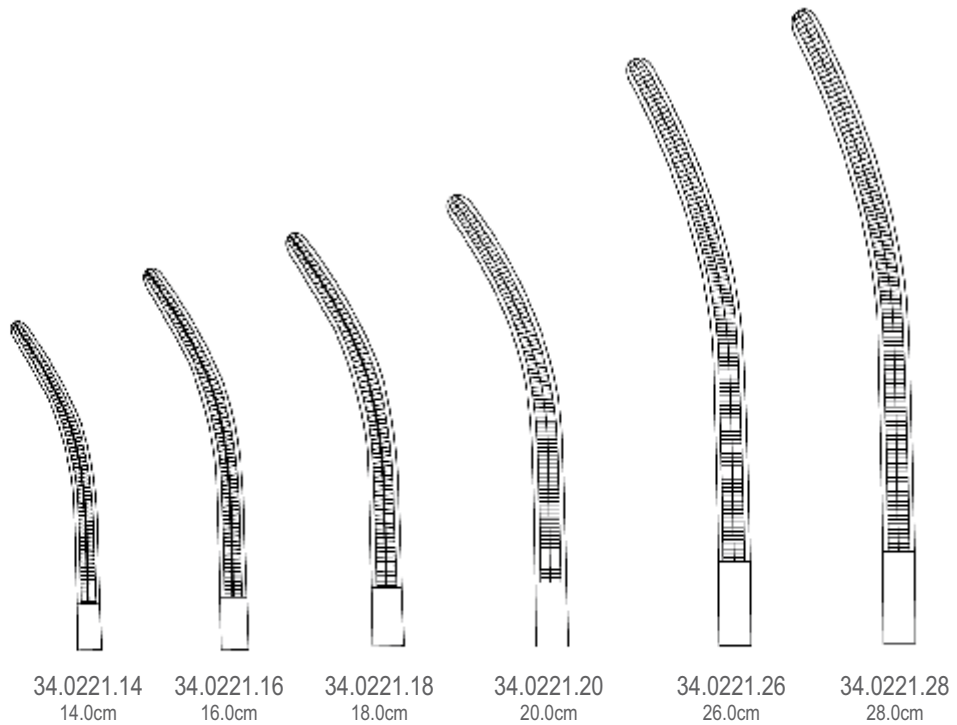

CARDIOVASCULAR

ALSO AVAILABLE IN TITANIUM

CARDIOVASCULAR

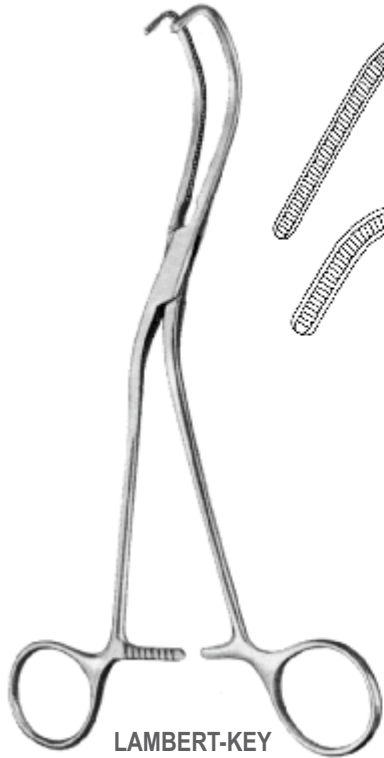

LAMBERT-KEY

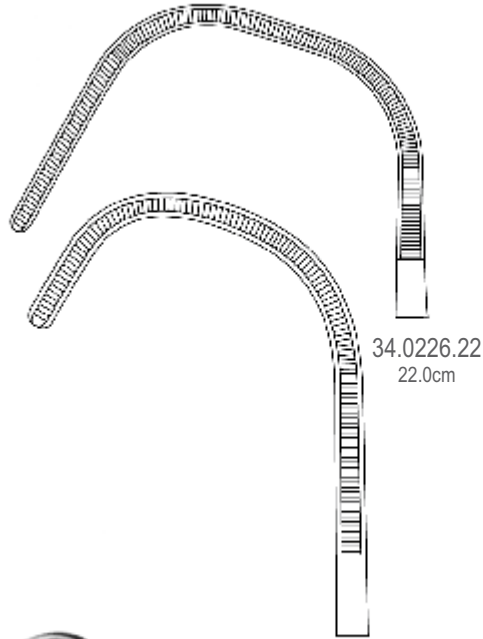

34.0226.22  
22.0cm

34.0226.21  
21.0cm

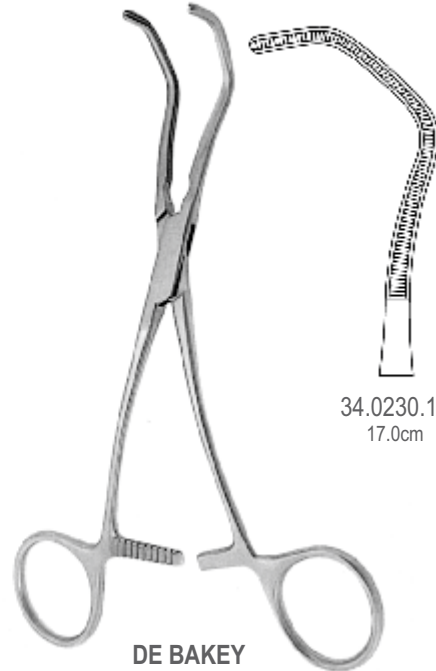

34.0230.17  
17.0cm

DE BAKEY



POTTS

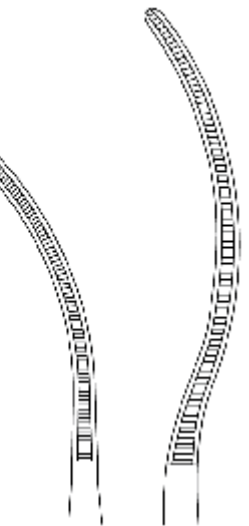

34.0234.22 22.0cm 34.0236.22 22.0cm

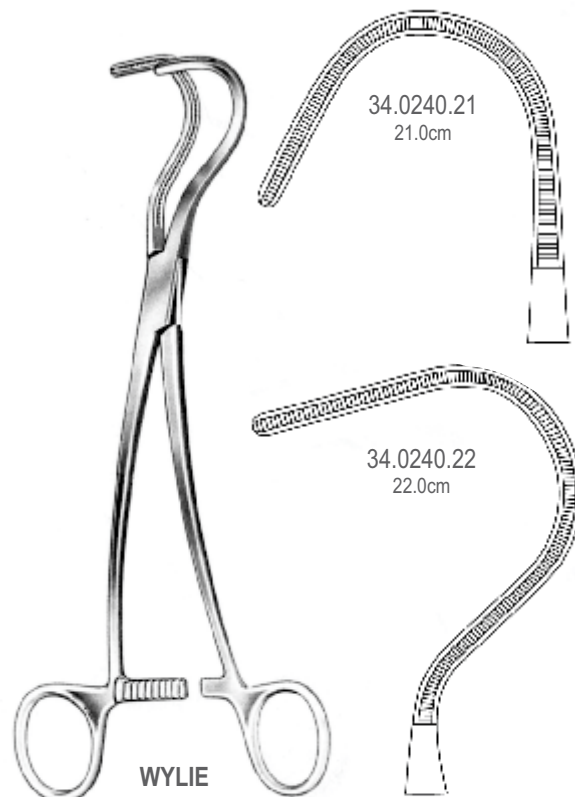

WYLIE

34.0240.21  
21.0cm

34.0240.22  
22.0cm

Atrauma Cardiovascular Forceps  
 Atrauma Cardiovascular-Klemmen  
 Atrauma pinzas-clamps cardiovasculares  
 Зажимы с атравматической нарезкой  
 非创伤性心血管钳



ALSO AVAILABLE IN TITANIUM

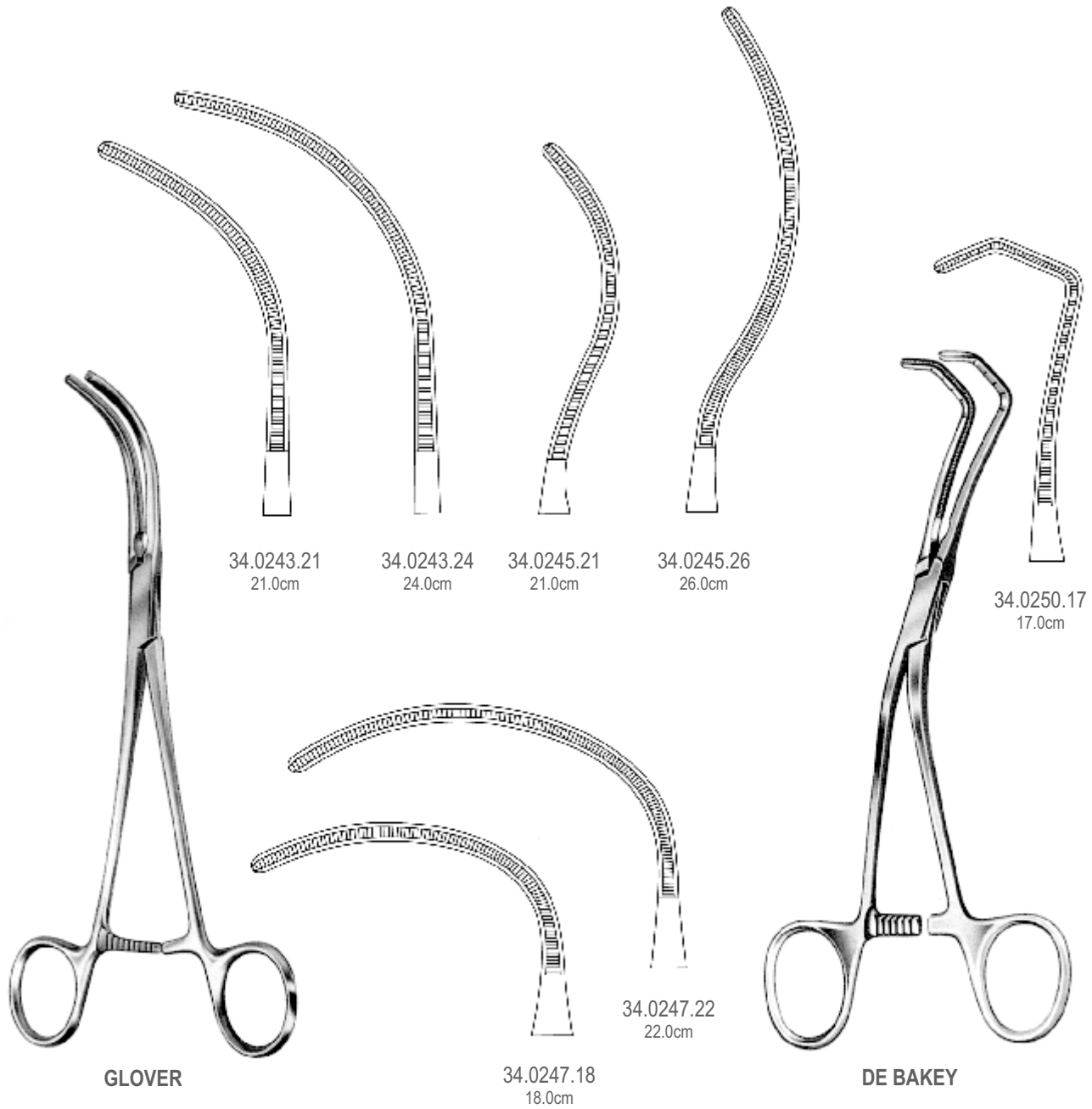

CARDIOVASCULAR

ALSO AVAILABLE IN TITANIUM

CARDIOVASCULAR



DE BAKEY-REYNOLDS

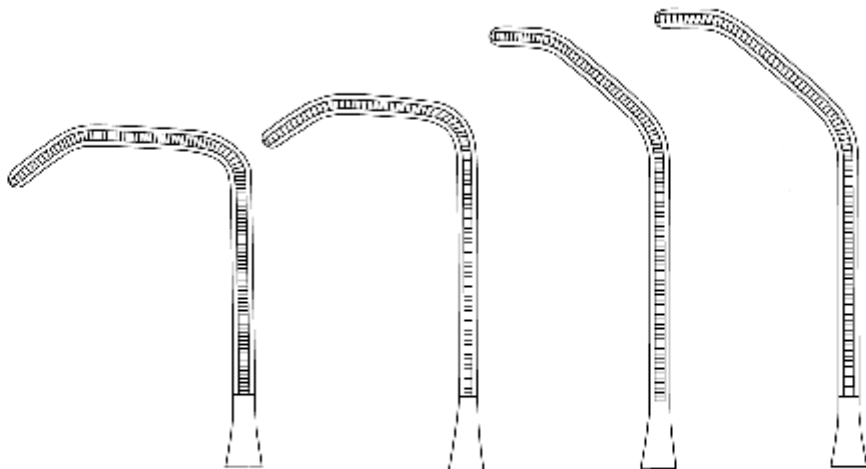

34.0254.16  
16.5cm

34.0256.16  
16.5cm

34.0254.18  
18.0cm

34.0256.18  
18.0cm

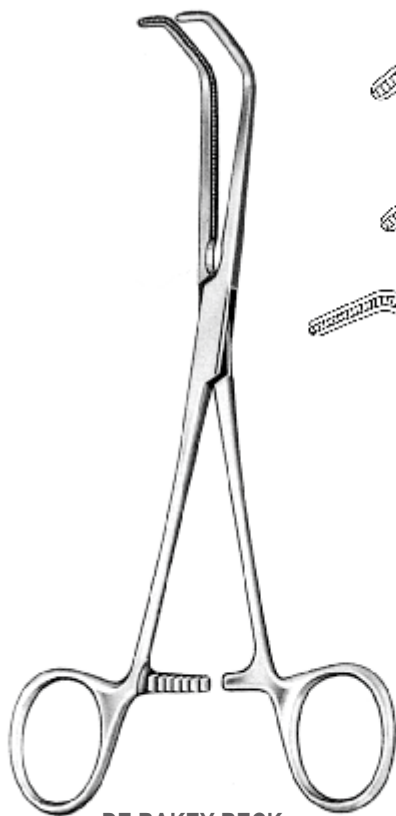

DE BAKEY-BECK

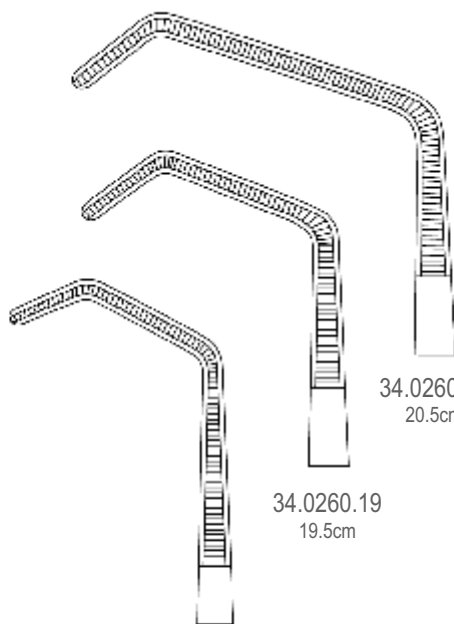

34.0260.16  
16.5cm

34.0260.19  
19.5cm

34.0260.20  
20.5cm

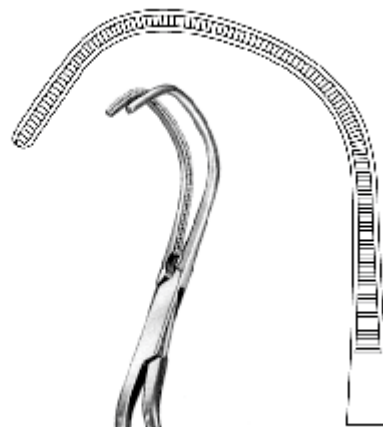

LIDDLE

34.0264.27  
27.0cm

Aortic Aneurysm Clamps  
Aorta-Aneurysmaklemmen  
Pinzas - clamps para aneurisma  
Зажимы с атравматической нарезкой, Зажимы для аорты  
主动脉动脉瘤夹



ALSO AVAILABLE IN TITANIUM

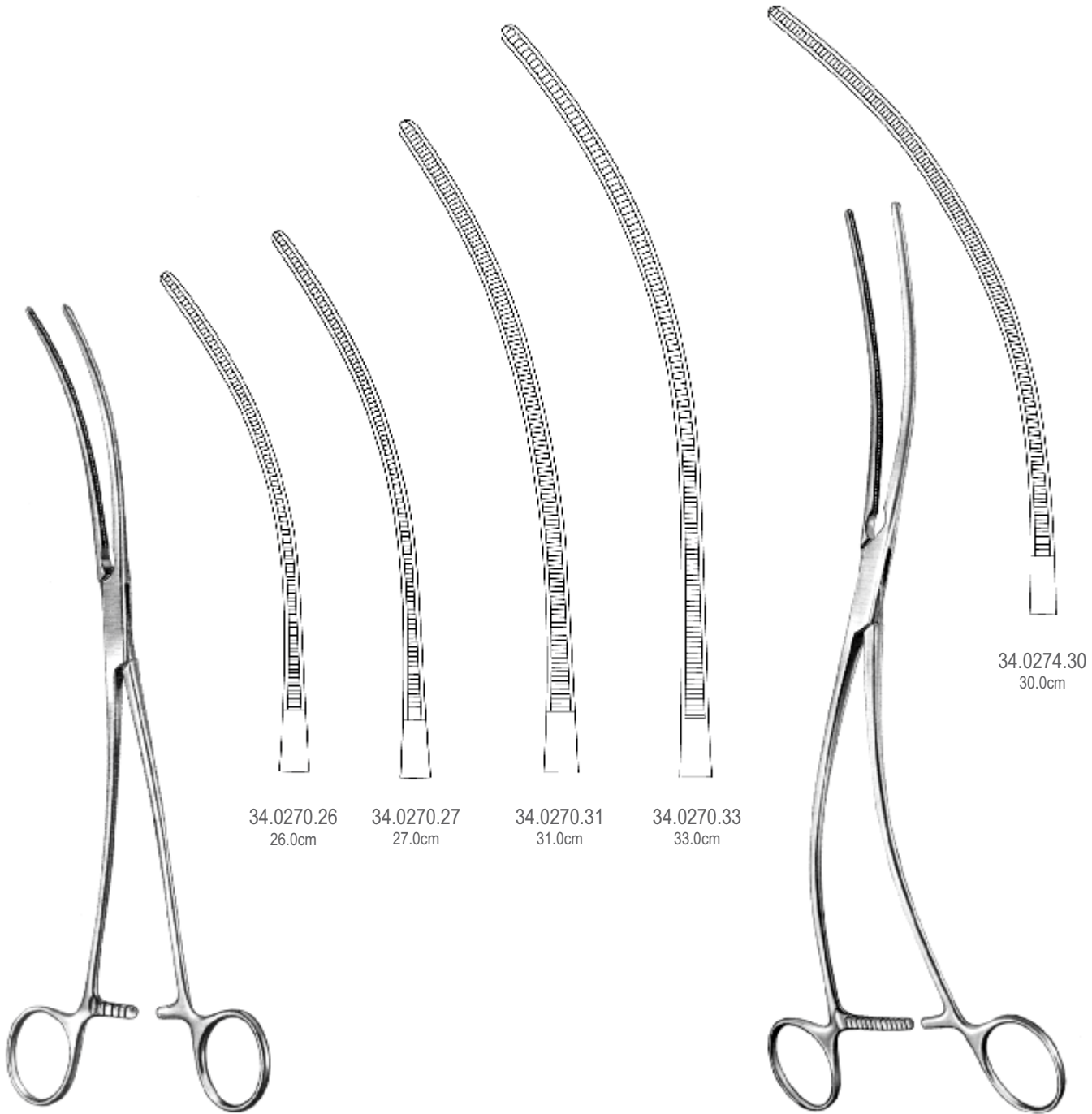

34.0270.26  
26.0cm

34.0270.27  
27.0cm

34.0270.31  
31.0cm

34.0270.33  
33.0cm

34.0274.30  
30.0cm

CARDIOVASCULAR

ALSO AVAILABLE IN TITANIUM

CARDIOVASCULAR

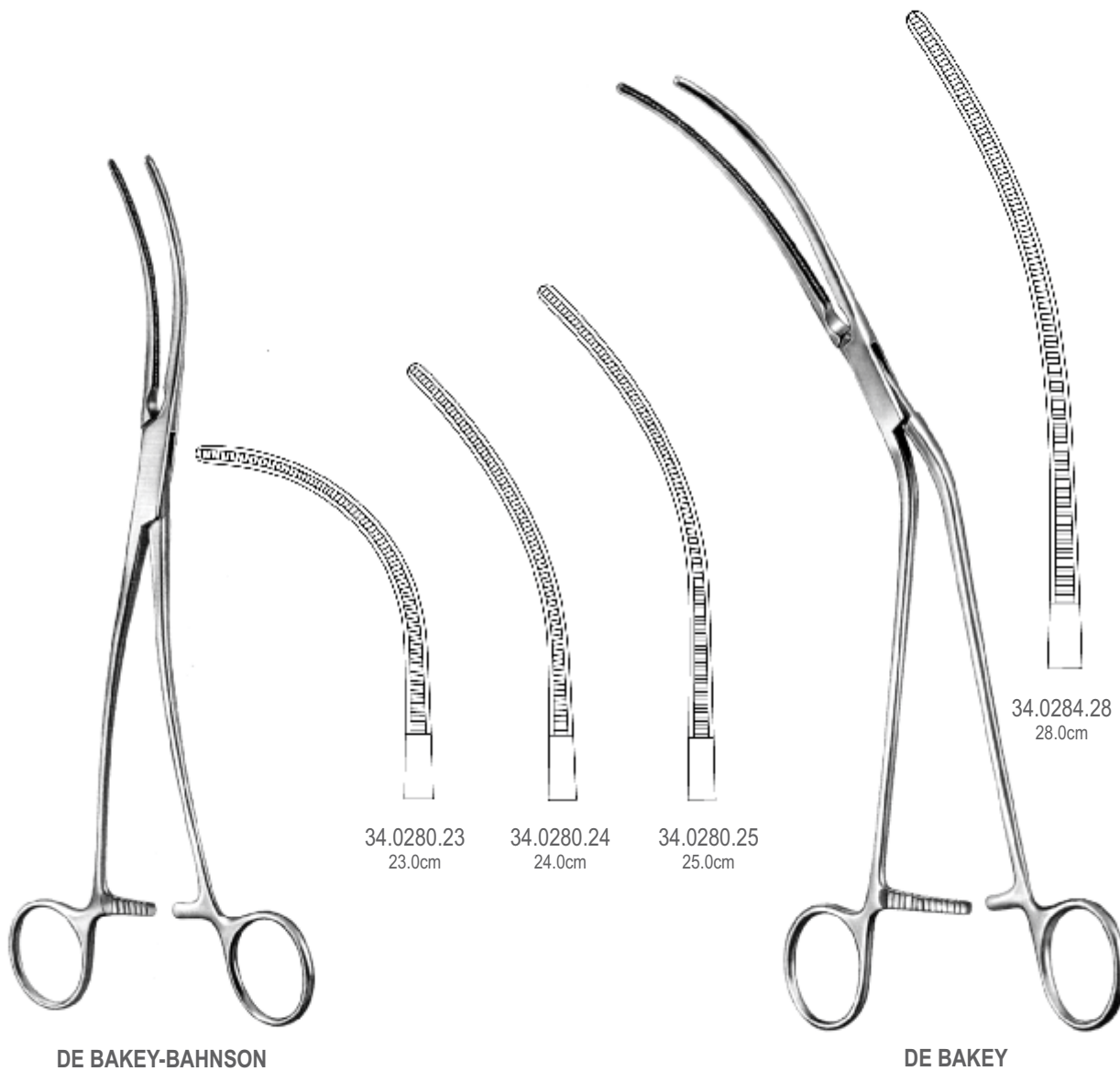

Aortic Clamps  
Aortaklemmen  
Pinzas-clamps para aorta  
Зажимы с атравматической нарезкой, Зажимы для аорты  
主动脉夹



ALSO AVAILABLE IN TITANIUM



**OCHSNER**  
34.0290.23 23.5cm  
34.0290.26 26.0cm

**DIETRICH**  
34.0294.21 21.0cm

**DE BAKEY**  
34.0300.26 26.0cm

CARDIOVASCULAR

Aortic Clamps  
Aortaklemmen  
Piznas-clamps para aorta  
Зажимы с атравматической нарезкой, Зажимы для аорты  
主动脉夹

ALSO AVAILABLE IN TITANIUM

CARDIOVASCULAR

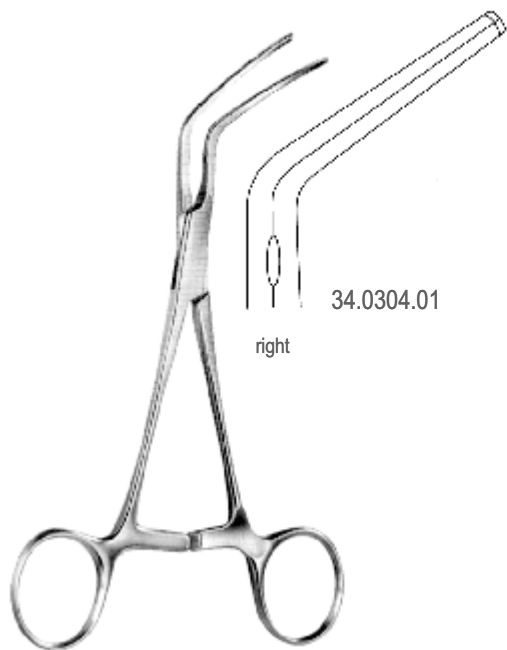

34.0304.01

right

**SUBRAMANIAN**  
16.0cm

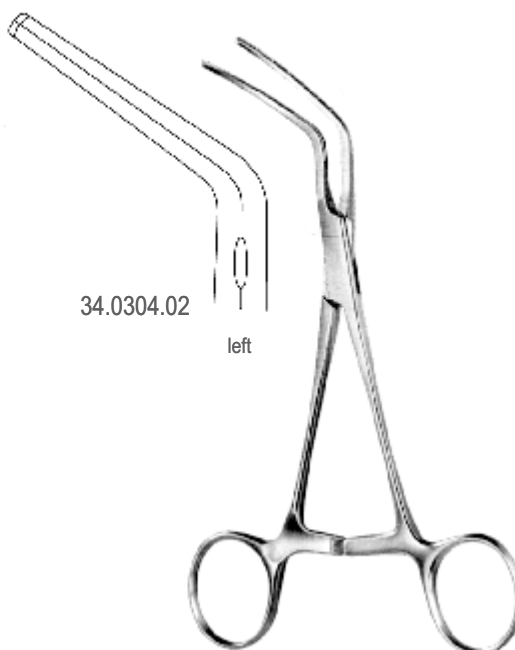

34.0304.02

left

**SUBRAMANIAN**  
16.0cm

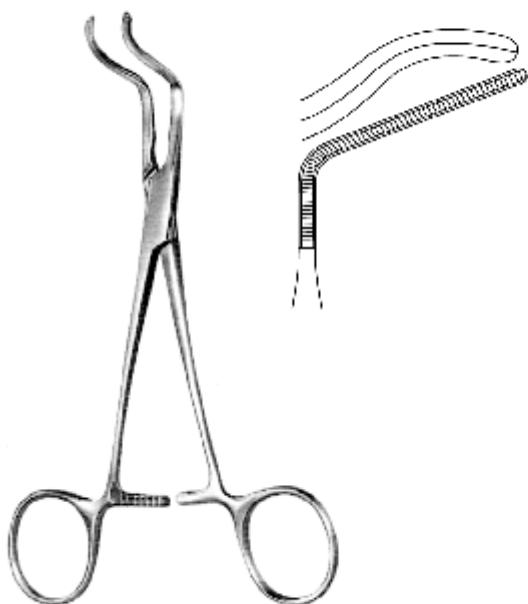

**SUBRAMANIAN-MINIATURE**  
34.0310.15 15.5cm

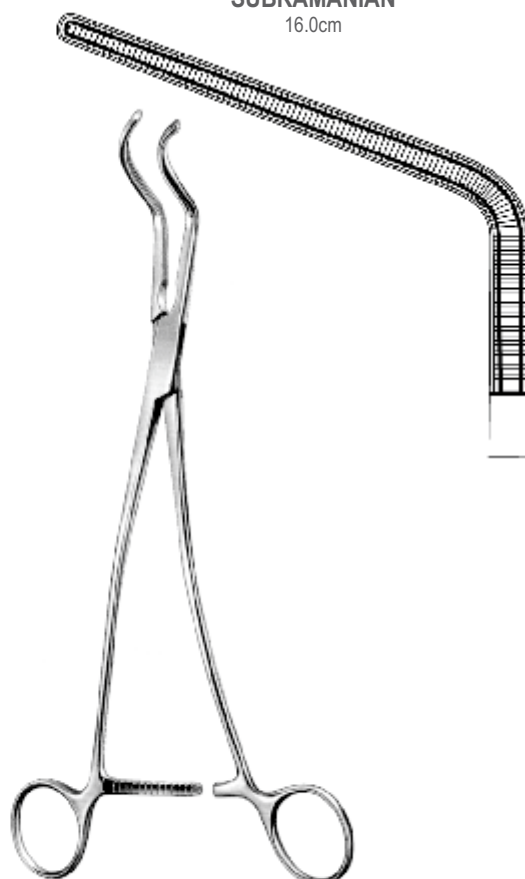

**DE BAKEY**  
34.0314.27 27.0cm

Aortic Clamps  
Aortaklemmen  
Pinzas-clamps para aorta  
Зажимы с атравматической нарезкой, Зажимы для аорты  
主动脉夹



ALSO AVAILABLE IN TITANIUM

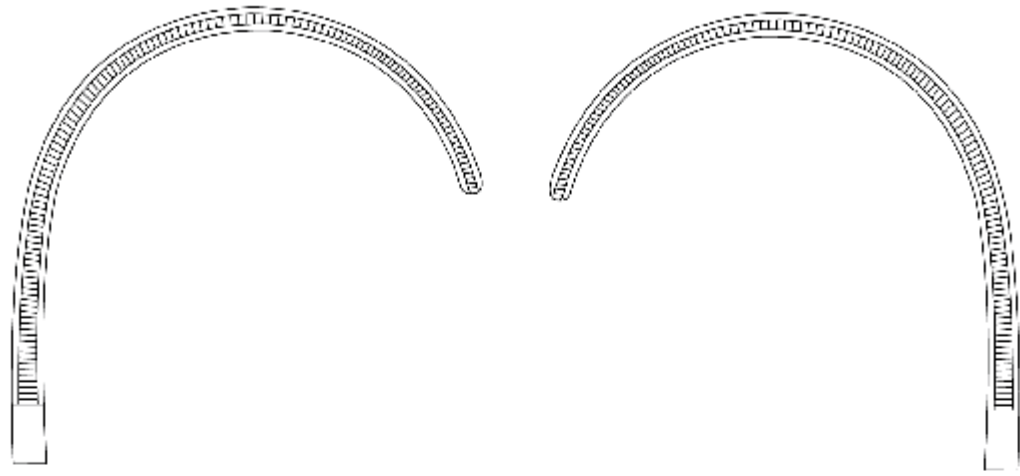

WEBER  
34.0320.01 26.0cm



WEBER  
34.0320.02 26.0cm

CARDIOVASCULAR

ALSO AVAILABLE IN TITANIUM

CARDIOVASCULAR

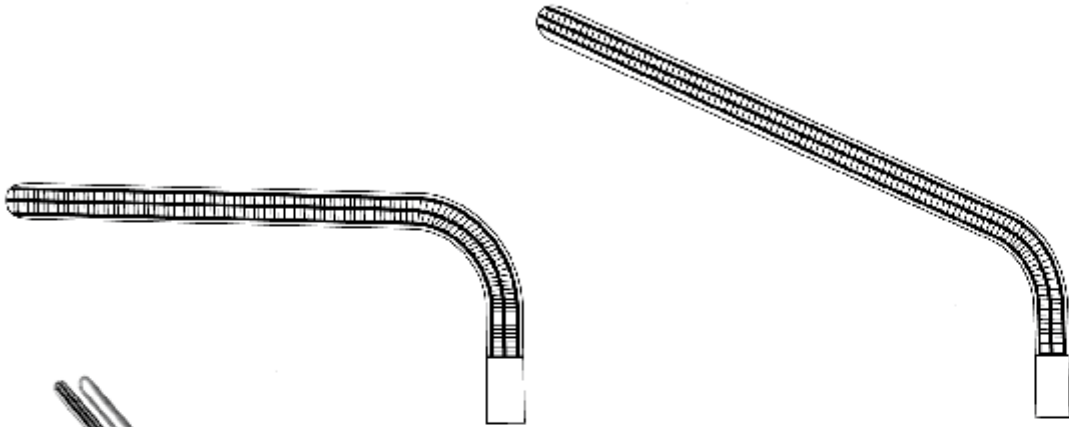

34.0324.18  
18.0cm

34.0324.20  
20.0cm



MORRIS - DE BAKEY

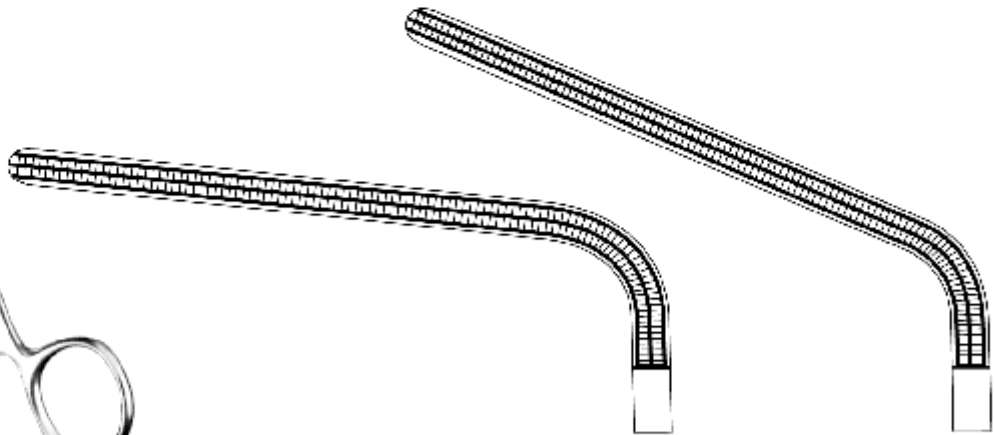

34.0324.23  
23.0cm

34.0324.25  
25.0cm

Tangential Occlusion Clamps  
 Tangentialklemmen  
 Pinzas-clamps para oclusion tangencial  
 Зажимы с атраватической нарезкой  
 切向闭塞夹



ALSO AVAILABLE IN TITANIUM



DE BAKEY  
SATINSKY



SATINSKY

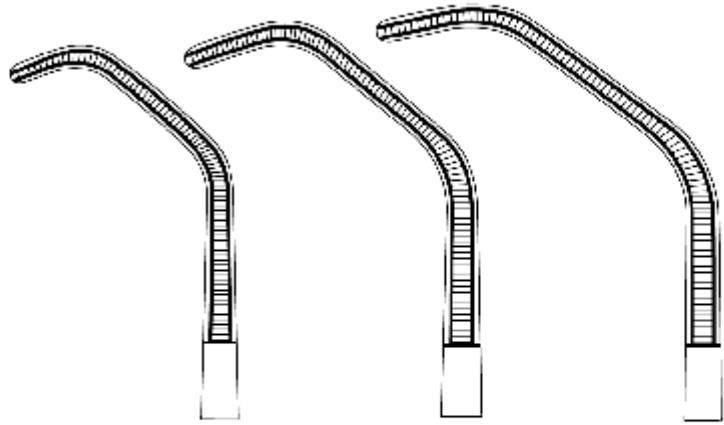
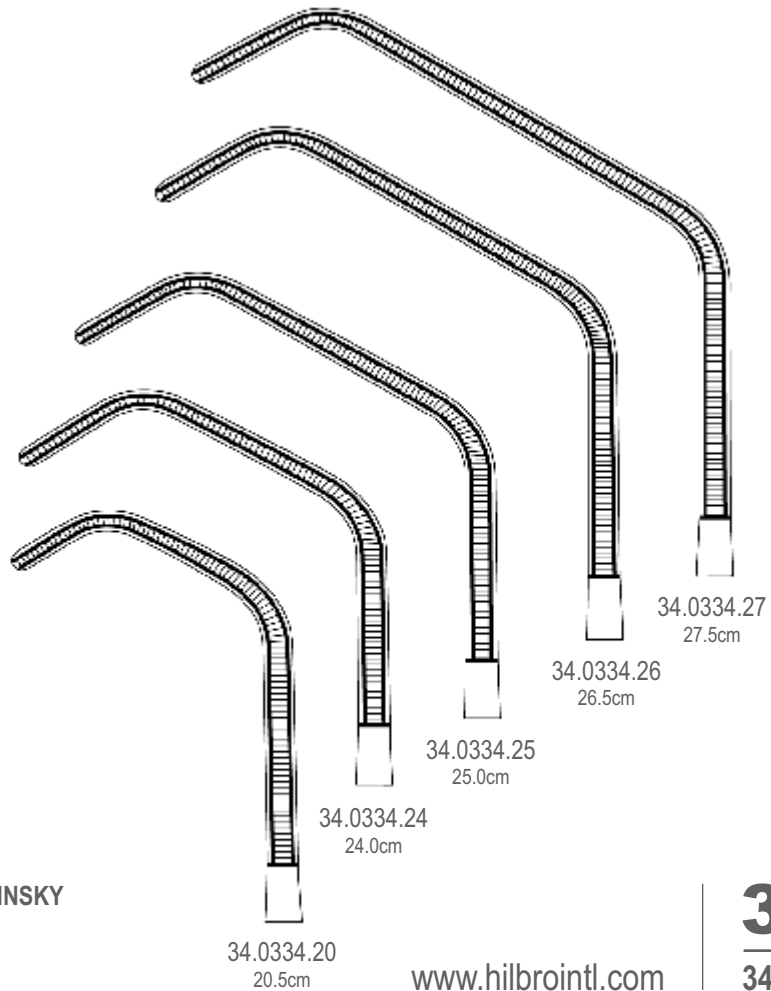

Fig.1 34.0330.23 23.5cm  
 Fig.2 34.0330.24 24.0cm  
 Fig.3 34.0330.25 25.0cm



34.0334.20 20.5cm  
 34.0334.24 24.0cm  
 34.0334.25 25.0cm  
 34.0334.26 26.5cm  
 34.0334.27 27.5cm

CARDIOVASCULAR

Coarctation forceps, Renal Artery Clamp

Coarctationsklemmen, Nieren-Arterienklemme

Pinzas-clamps para coarctacion, pinzas-clamps para arteria renal

Зажимы с атравматической нарезкой, Зажимы для коарктации, Зажимы для почечной артерии

缩窄钳，肾动脉夹

ALSO AVAILABLE IN TITANIUM

CARDIOVASCULAR

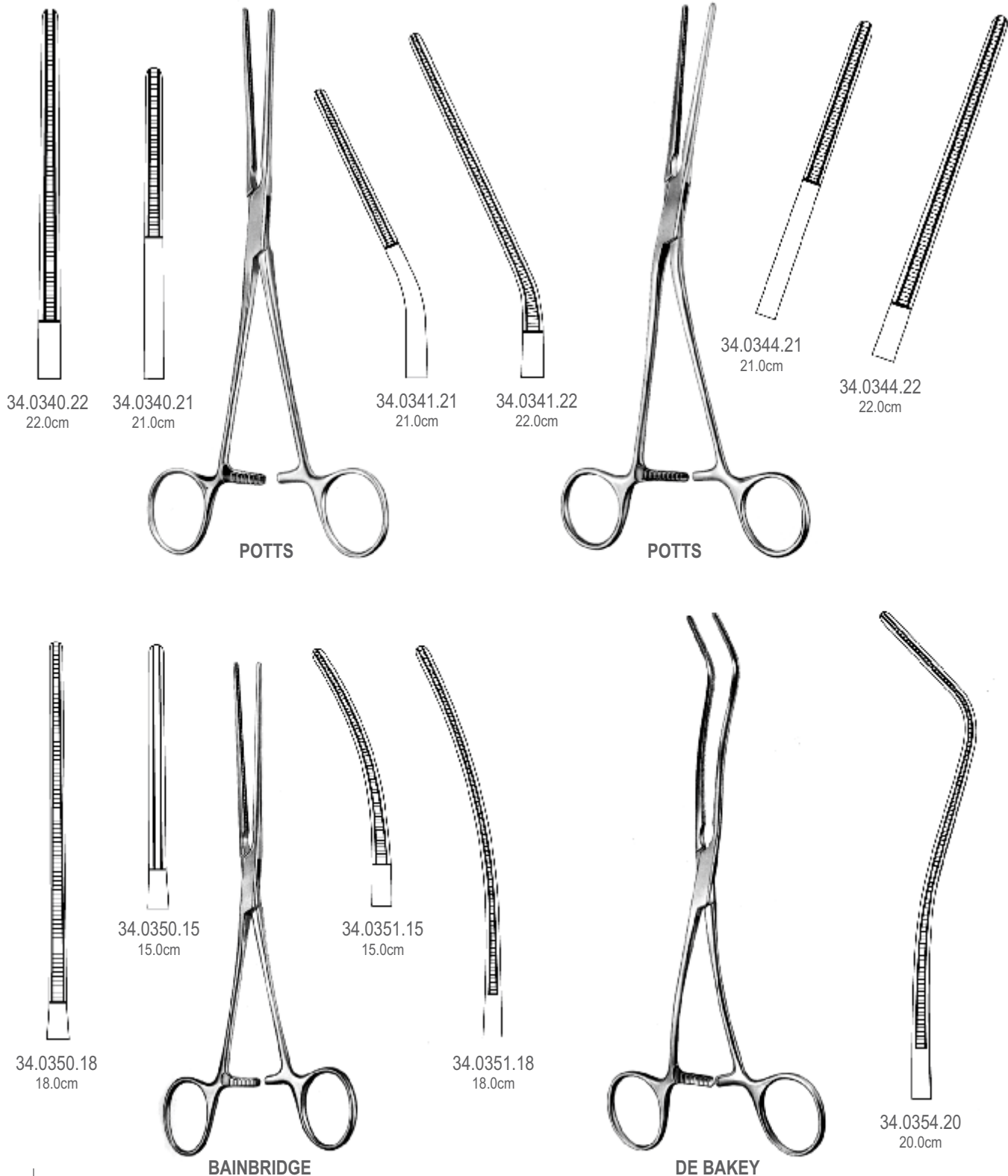

Profunda Clamps, Peripheral Vascular Clamps

Profundaklemmen, Peripheral-Gefaßklemmen

Pinzas-clamps para la profunda, pinzas-clamps para vasos perifericos

Зажимы с атравматической нарезкой, Зажимы для глубоких полостей, Периферийные сосудистые зажимы

周围血管夹



ALSO AVAILABLE IN TITANIUM



GREGORY



34.0360.14  
14.0cm

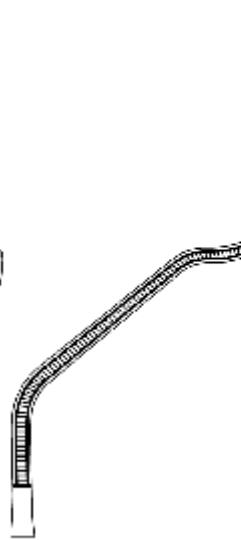

34.0360.16  
16.0cm



34.0360.18  
18.0cm

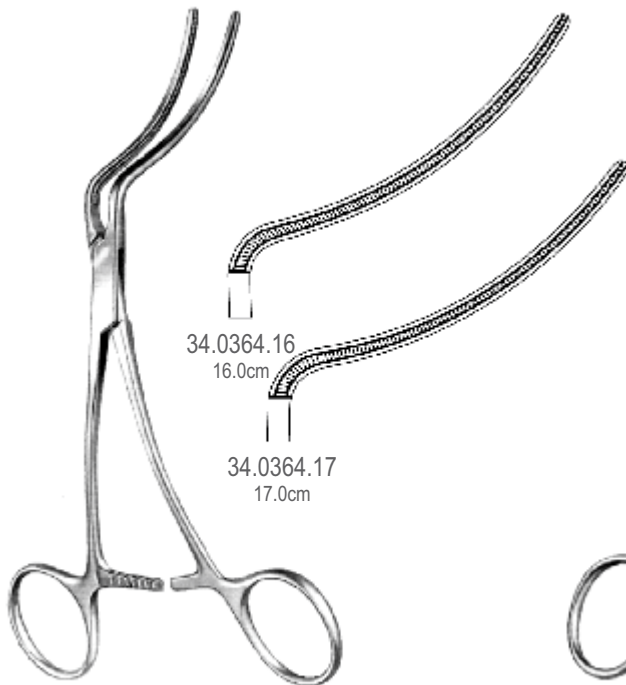

34.0364.16  
16.0cm

34.0364.17  
17.0cm

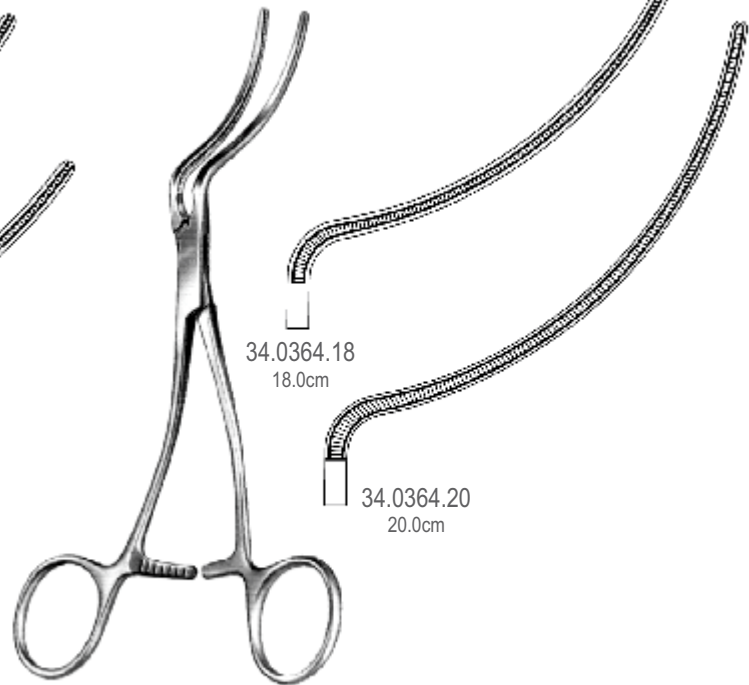

34.0364.18  
18.0cm

34.0364.20  
20.0cm

CARDIOVASCULAR

Peripheral Vascular Clamps

Peripheral-GefaßKlemmen

Pinzas-clamps para vasos perifericos

Зажимы с атравматической нарезкой, Периферийные сосудистые зажимы

周围血管夹

ALSO AVAILABLE IN TITANIUM

CARDIOVASCULAR

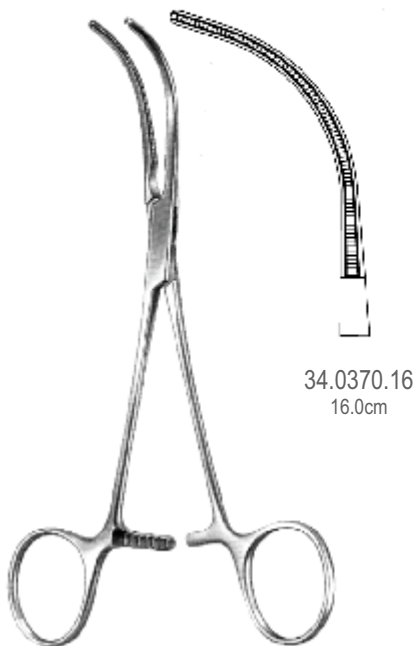

34.0370.16  
16.0cm

DE BAKEY

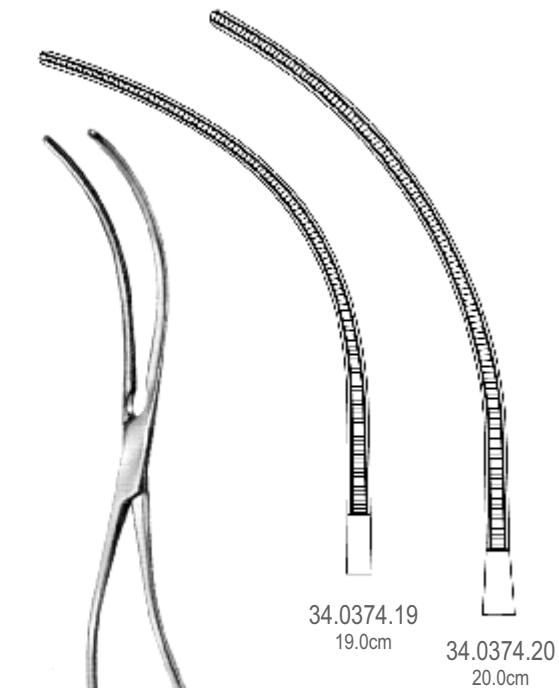

34.0374.19  
19.0cm

34.0374.20  
20.0cm

DE BAKEY



34.0380.26  
26.0cm

DE BAKEY

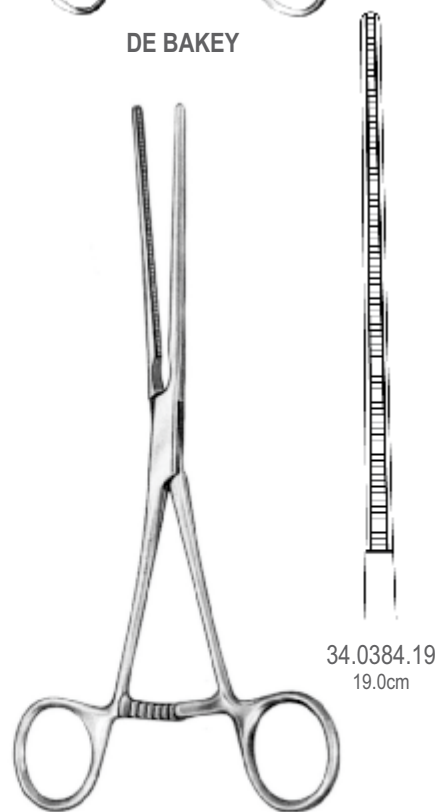

34.0384.19  
19.0cm

LELAND JONES

Peripheral Vascular Clamps  
 Peripheral-Gefaßklemmen  
 Pinzas-clamps para vasos perifericos  
 Зажимы с атравматической нарезкой, Периферийные сосудистые зажимы  
 周围血管夹



ALSO AVAILABLE IN TITANIUM



LELAND JONES

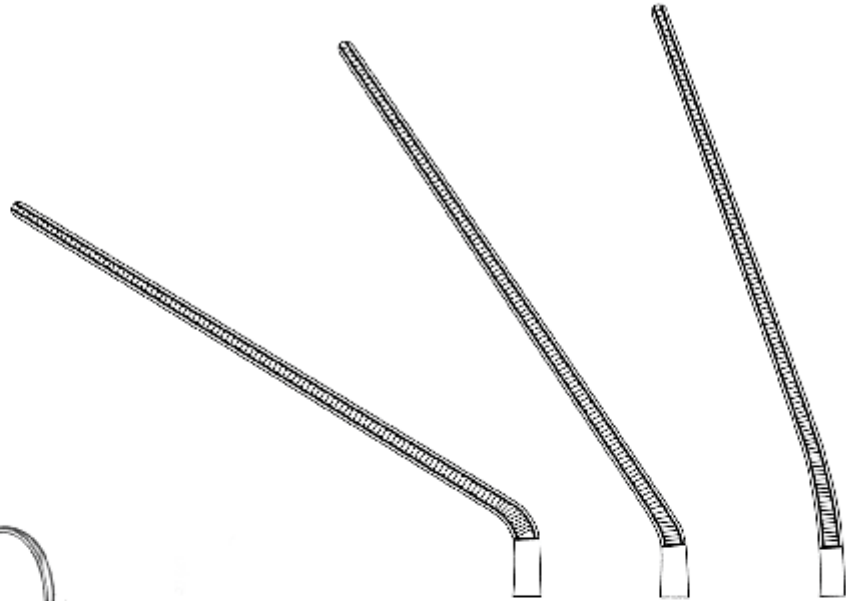

34.0390.18  
18.0cm

34.0390.19  
19.0cm

34.0390.20  
20.0cm



DALE

34.0394.18  
18.5cm



DALE

34.0400.17  
17.0cm

34.0400.18  
18.0cm

34.0400.19  
19.0cm

CARDIOVASCULAR

Ligature Clamps

Ligaturklemmen

Pinzas para ligadura

Зажимы с атравматической нарезкой, Зажимы лигатурные

结扎夹

ALSO AVAILABLE IN TITANIUM

CARDIOVASCULAR



DE BAKEY



34.0404.19  
19.0cm



34.0404.23  
23.0cm



DE BAKEY

34.0410.24  
24.0cm



DE BAKEY

34.0414.24  
24.0cm

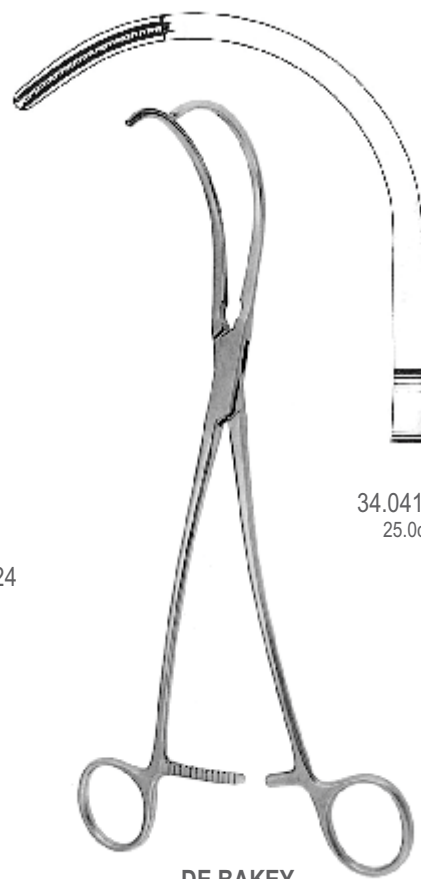

DE BAKEY

34.0414.25  
25.0cm

Auricle Clamps, Bronchus Clamps  
 Aurikeklappen, Bronchusklemmen  
 Pinzas clamps para auricula, pinzas clamps bronquiales  
 Зажимы с атравматической нарезкой, Зажимы для предсердия, Зажимы для бронхов  
 耳廓线夹, 支气管夹



ALSO AVAILABLE IN TITANIUM



**HARKEN**  
24.0cm



34.0420.01

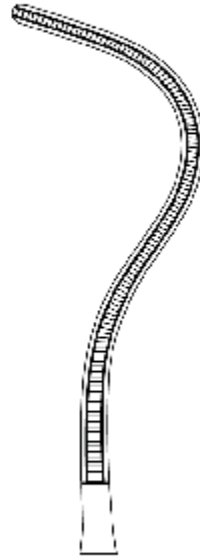

34.0420.02

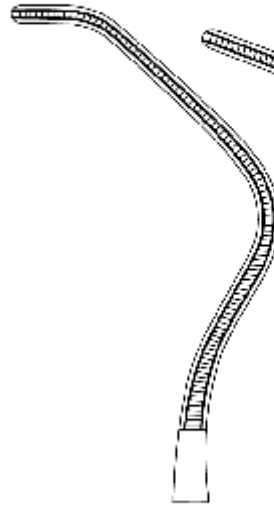

34.0420.03

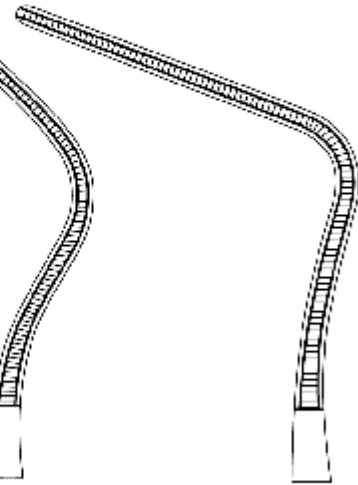

34.0420.04



**LEES**

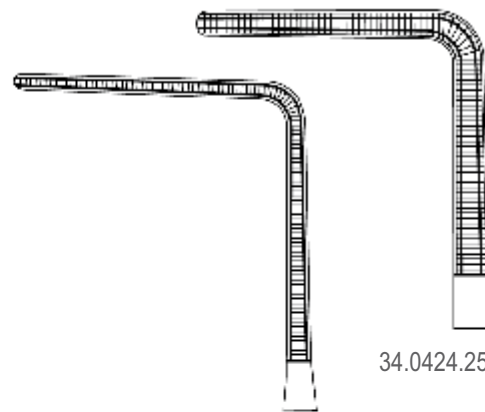

34.0424.23 23.0cm

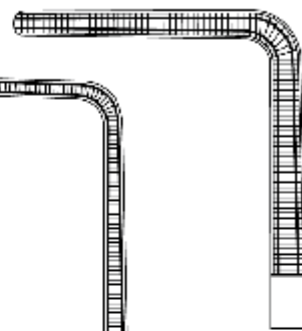

34.0424.25 25.0cm



**LEES**

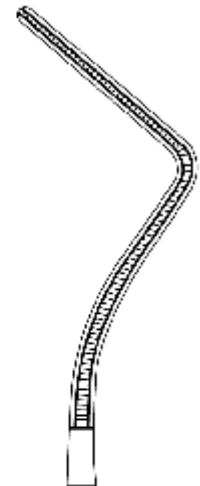

34.0430.25 25.0cm

CARDIOVASCULAR

Coarctation Clamps  
Coarctationsklemmen  
Pinzas clamps para coarctacion  
Зажимы с атравматической нарезкой, Зажимы для коарктации  
缩窄夹

ALSO AVAILABLE IN TITANIUM

CARDIOVASCULAR



34.0434.21  
21.0cm



34.0434.23  
23.0cm



34.0434.27  
27.0cm



34.0434.31  
31.0cm

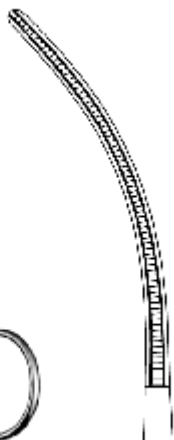

34.0435.21  
21.0cm



34.0435.23  
23.0cm



34.0435.27  
27.0cm



34.0435.31  
31.0cm

Multi Purpose Clamps  
 Mehrzweckklemmen  
 Pinzas-clamps para usos varios  
 Зажимы с атравматической нарезкой  
 非创伤性心血管钳



ALSO AVAILABLE IN TITANIUM

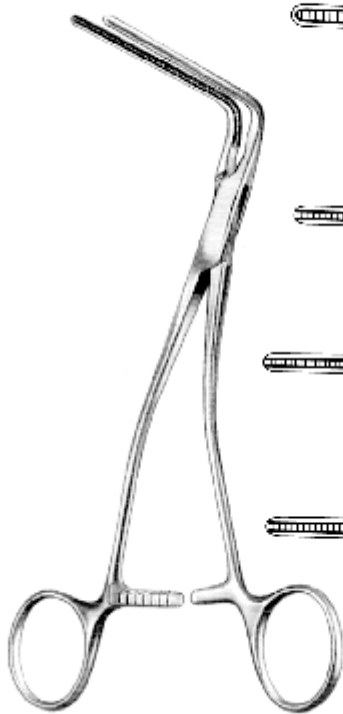

DE BAKEY

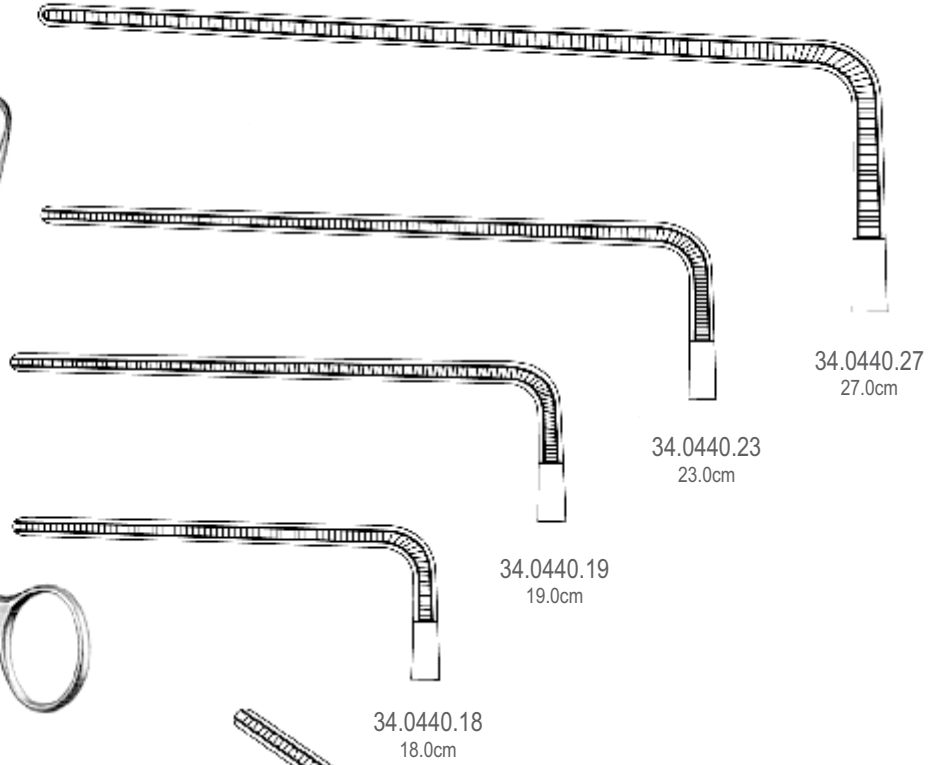

DE BAKEY

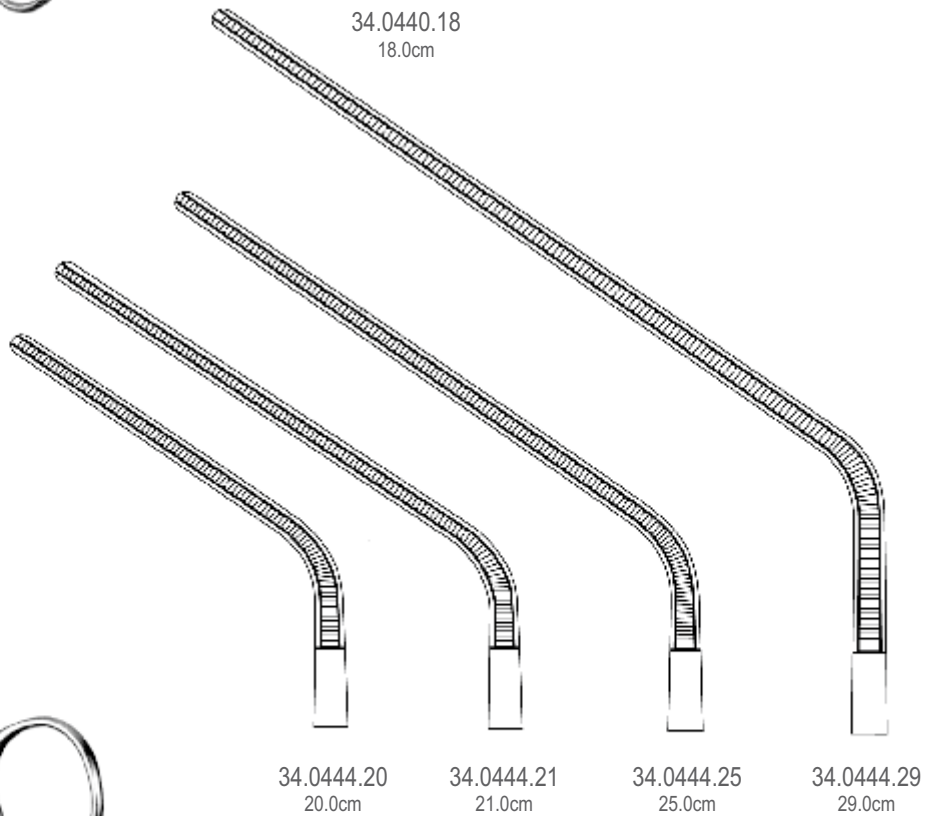

CARDIOVASCULAR

ALSO AVAILABLE IN TITANIUM

CARDIOVASCULAR

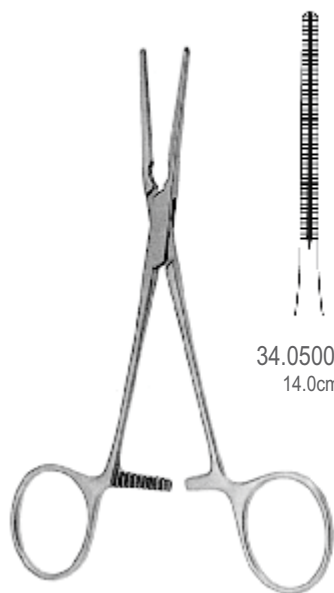

34.0500.01  
14.0cm

COOLEY



34.0500.02  
14.0cm

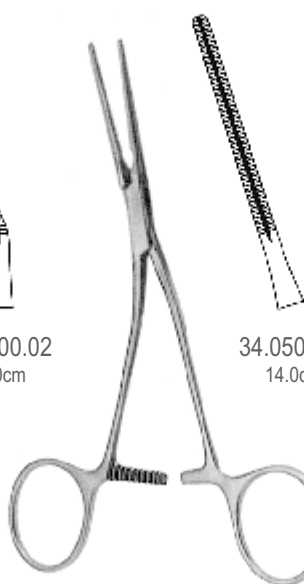

34.0500.03  
14.0cm

COOLEY



34.0500.04  
14.0cm

COOLEY



34.0500.05  
14.0cm

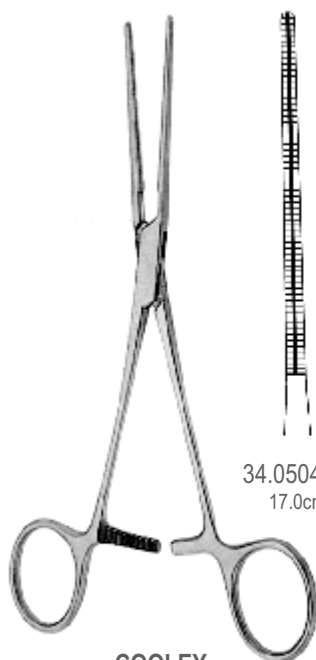

34.0504.17  
17.0cm

COOLEY

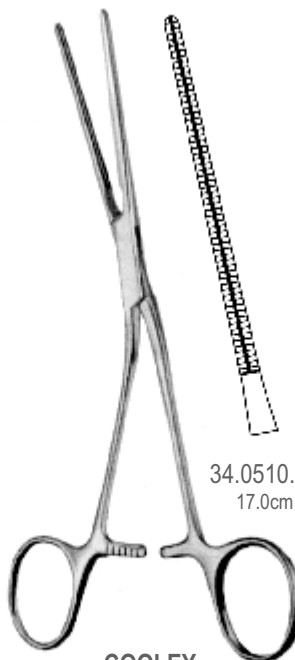

34.0510.17  
17.0cm

COOLEY

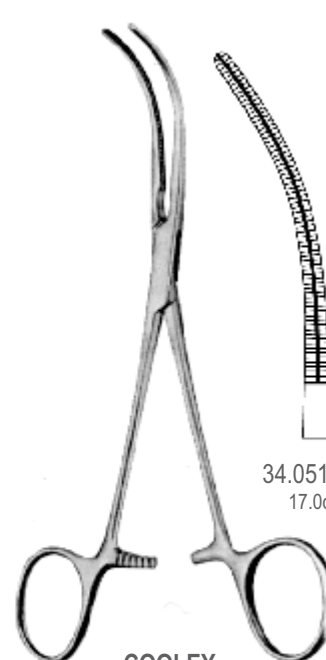

34.0514.17  
17.0cm

COOLEY

Atrauma Cardiovascular Forceps  
 Atrauma Cardiovascular-Klemmen  
 Atrauma pinzas-clamps cardiovasculares  
 Зажимы с атравматической нарезкой  
 非创伤性心血管钳



ALSO AVAILABLE IN TITANIUM



COOLEY  
 34.0520.17 17.0cm

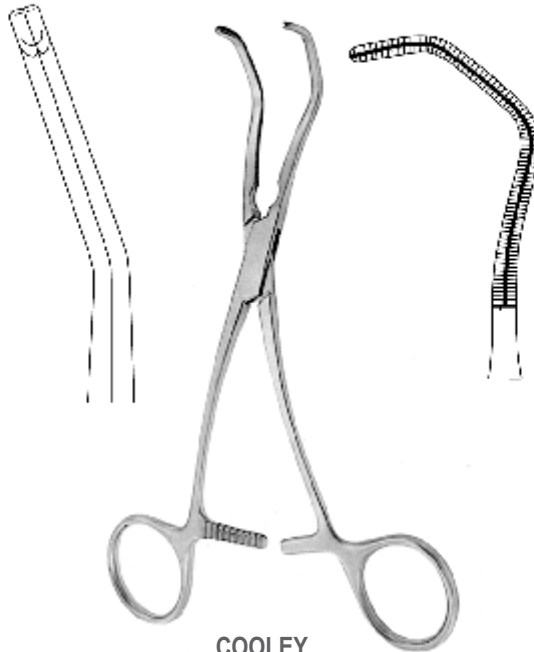

COOLEY  
 34.0524.16 16.0cm

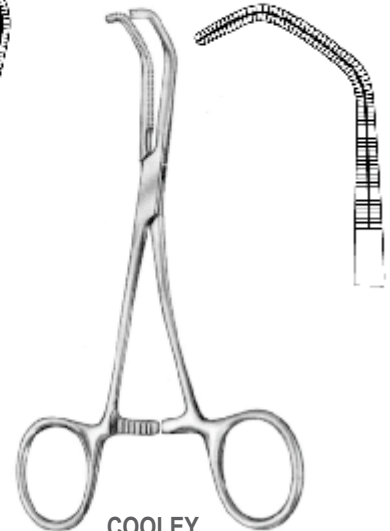

COOLEY  
 34.0530.14 14.0cm

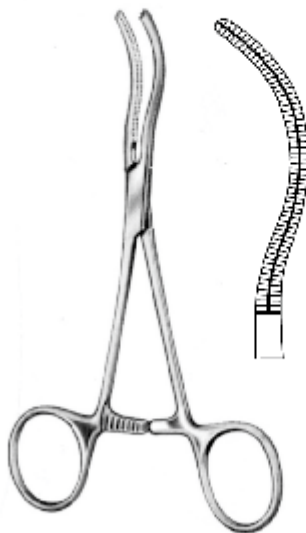

COOLEY  
 34.0534.14 14.0cm

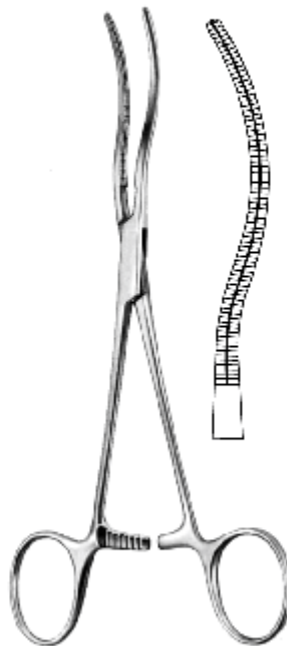

COOLEY  
 34.0540.17 17.0cm

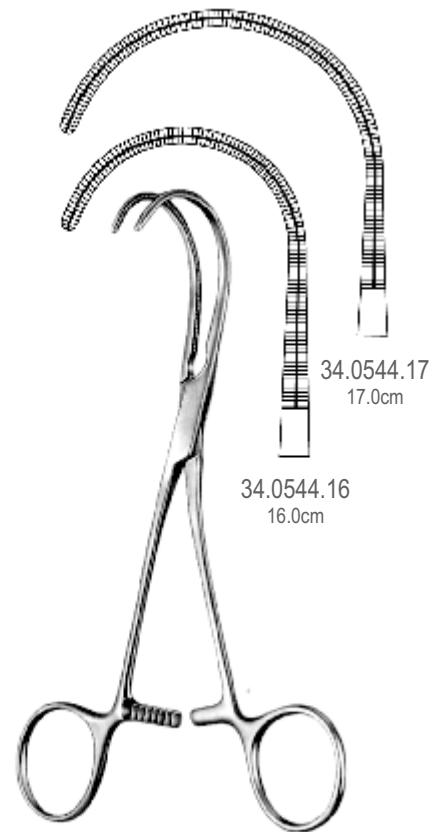

34.0544.16  
 16.0cm

34.0544.17  
 17.0cm

COOLEY

CARDIOVASCULAR

ALSO AVAILABLE IN TITANIUM

CARDIOVASCULAR



COOLEY-DERRA

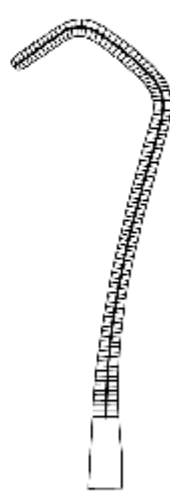

34.0550.16  
16.0 cm

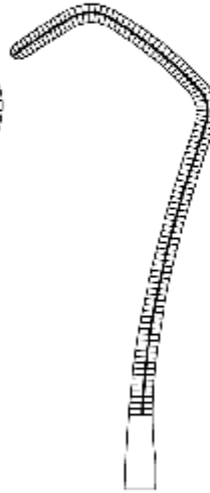

34.0550.17  
17.0 cm

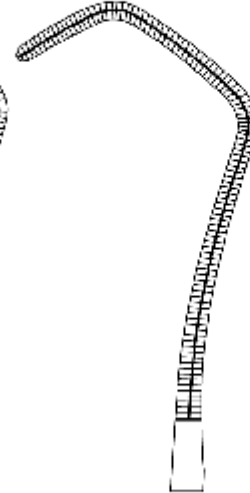

34.0550.18  
18.0 cm



COOLEY

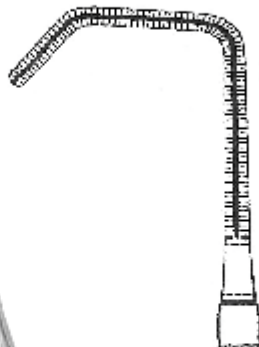

34.0560.01  
16.5 cm

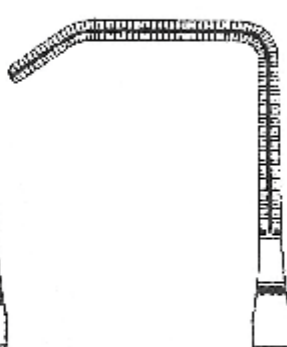

34.0560.02  
16.5 cm

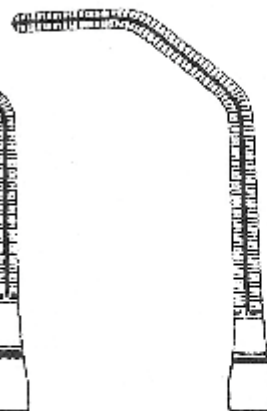

34.0560.03  
17.5 cm

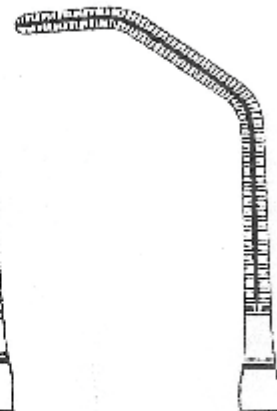

34.0560.04  
17.5 cm

Atrauma Forceps  
Atrauma Klemmen  
Atrauma pinzas-clamps  
Зажимы с атравматической нарезкой  
非创伤性镊子



ALSO AVAILABLE IN TITANIUM

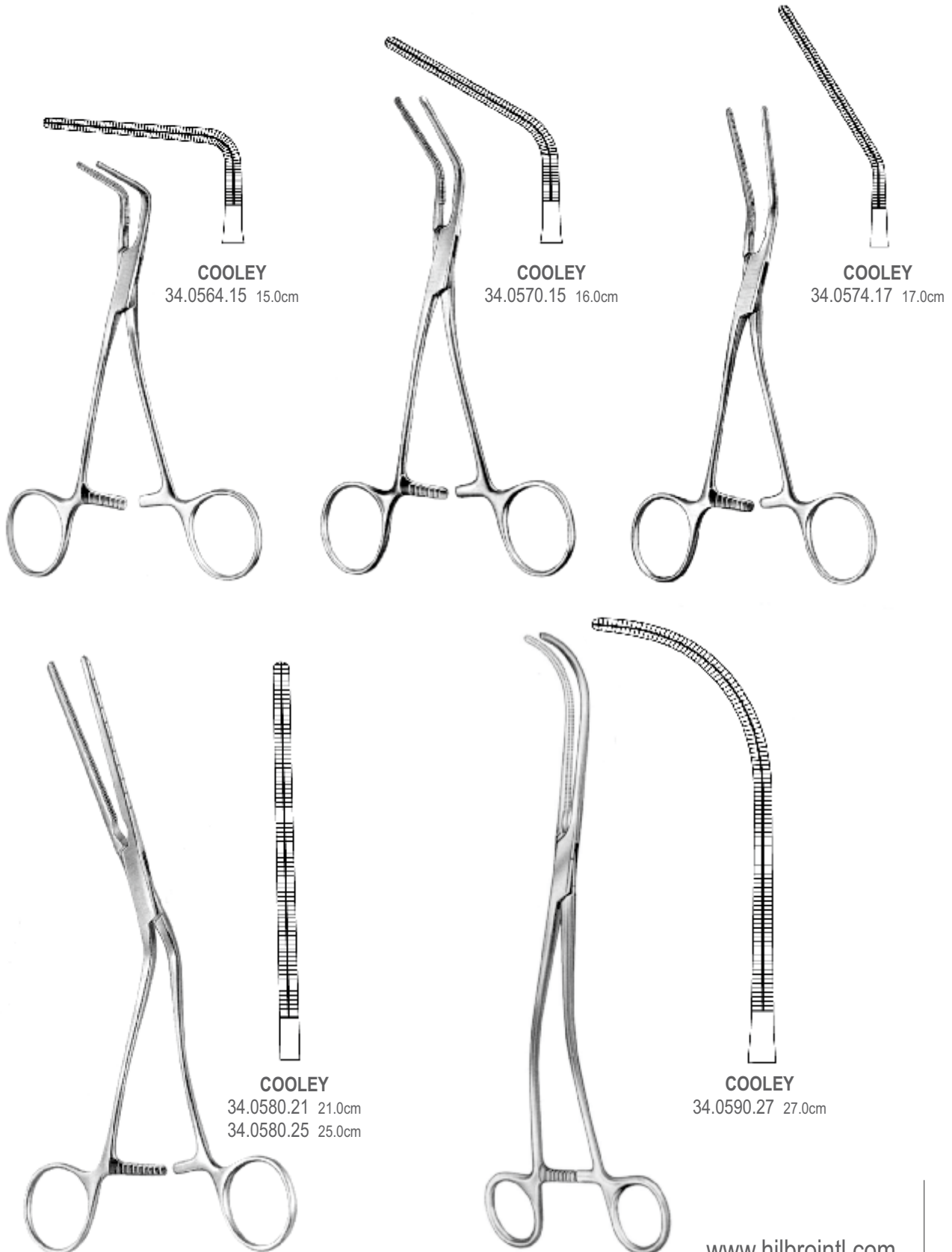

CARDIOVASCULAR

ALSO AVAILABLE IN TITANIUM

CARDIOVASCULAR

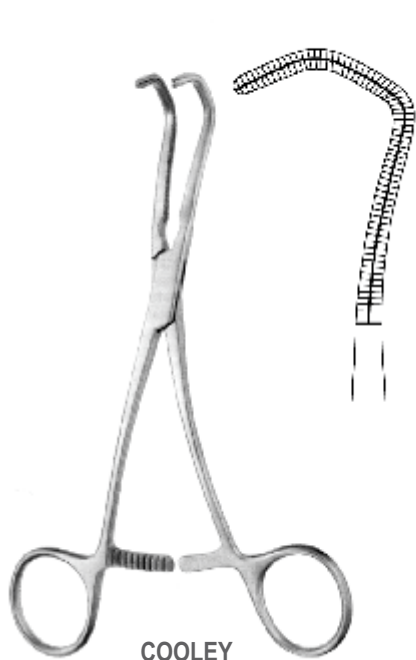

COOLEY  
34.0594.17 17.0cm

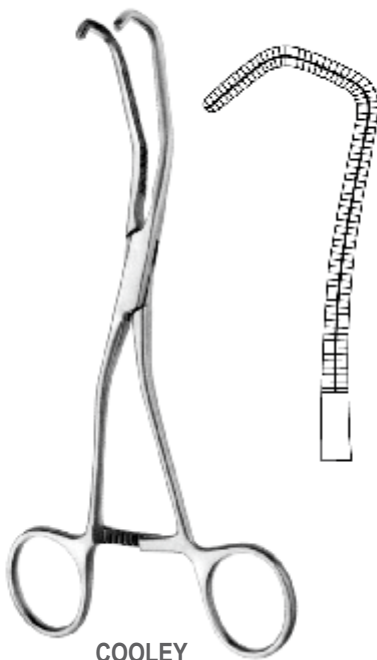

COOLEY  
34.0596.17 17.0cm

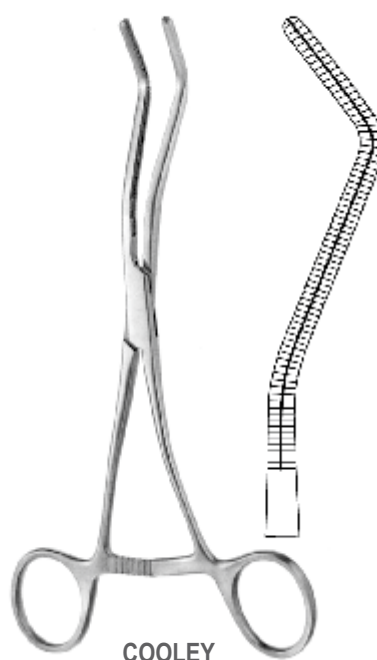

COOLEY  
34.0600.18 18.0cm

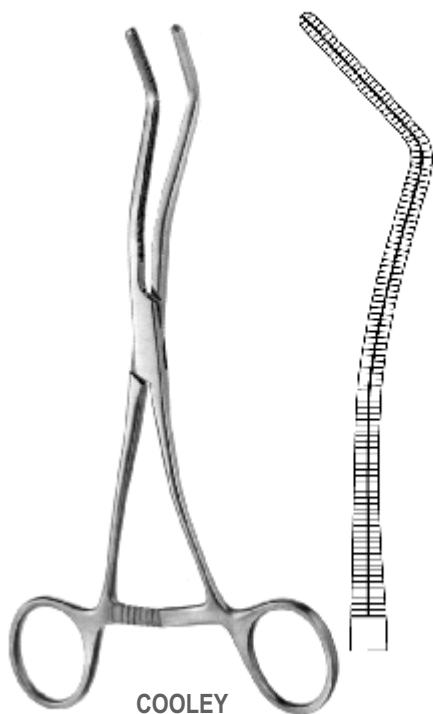

COOLEY  
34.0602.19 19.0cm

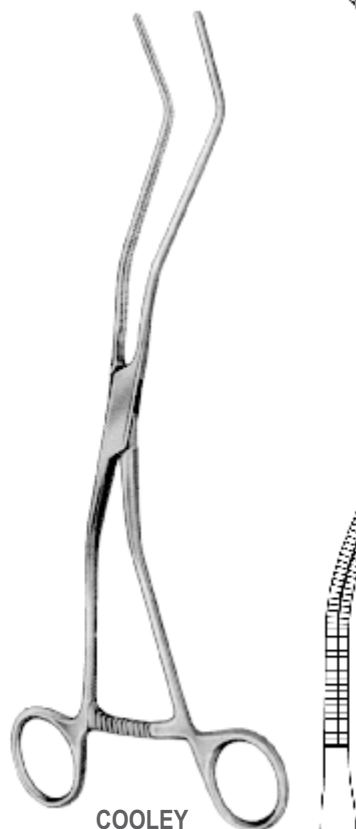

COOLEY  
34.0604.26 26.0cm

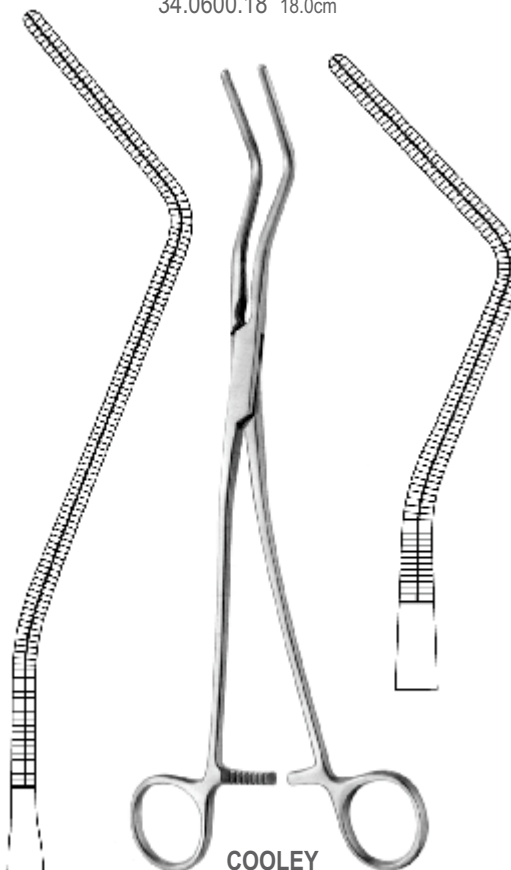

COOLEY  
34.0606.27 27.0cm

Atrauma and Pediatric Clamps  
Atrauma Neonatal-und Kinderklemmen  
Atrauma pinzas clamps para recién nacidos y pediátricos  
Зажимы с атравматической нарезкой, Зажимы детские  
非创伤性和小儿夹



ALSO AVAILABLE IN TITANIUM

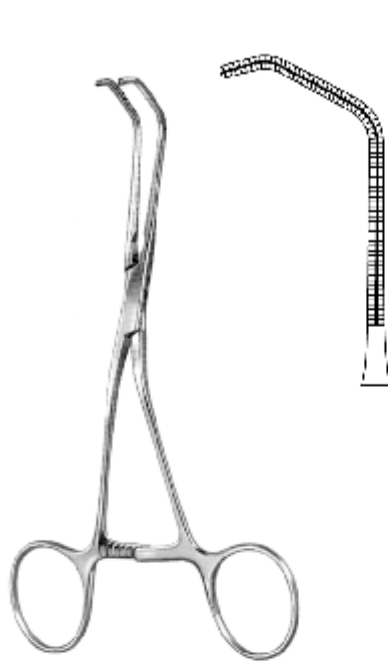

34.0610.15 15.0cm

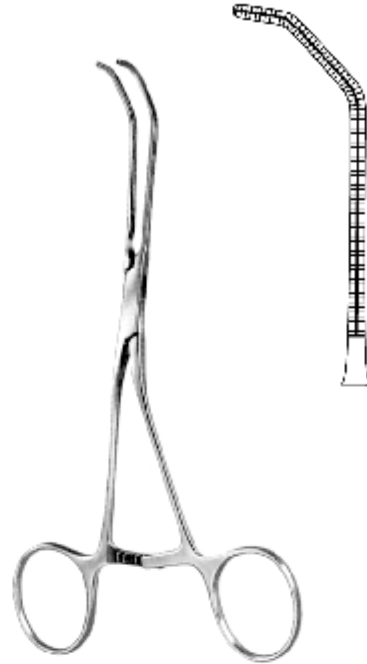

34.0614.15 15.5cm

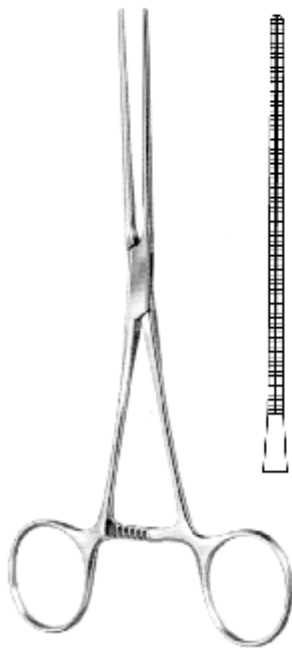

34.0620.16 16.5cm

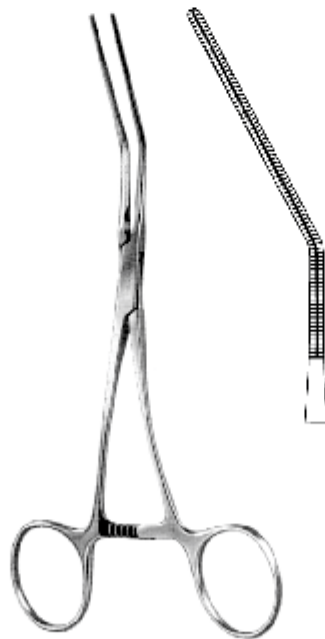

34.0622.16 16.0cm

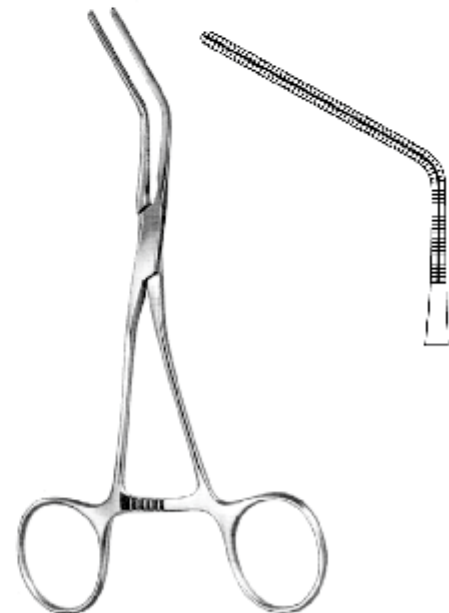

34.0624.15 15.0cm

CARDIOVASCULAR

ALSO AVAILABLE IN TITANIUM

CARDIOVASCULAR

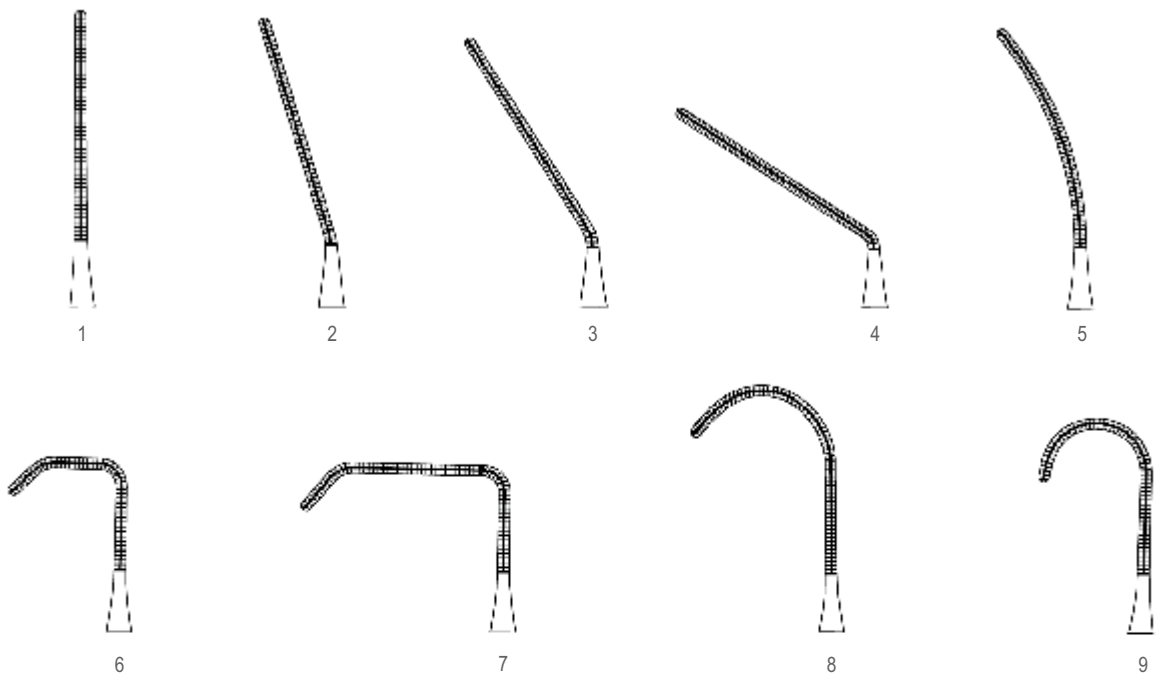

1 34.0630.01 14.5cm  
 2 34.0630.02 14.5cm  
 3 34.0630.03 14.5cm  
 4 34.0630.04 13.5cm  
 5 34.0630.05 14.0cm  
 6 34.0630.06 13.5cm  
 7 34.0630.07 13.5cm  
 8 34.0630.08 14.0cm  
 9 34.0630.09 13.5cm



1 34.0632.01 14.5cm  
 2 34.0632.02 14.5cm  
 3 34.0632.03 14.5cm  
 4 34.0632.04 13.5cm  
 5 34.0632.05 14.0cm  
 6 34.0632.06 13.5cm  
 7 34.0632.07 13.5cm  
 8 34.0632.08 14.0cm  
 9 34.0632.09 13.5cm



1 34.0634.01 14.5cm  
 2 34.0634.02 14.5cm  
 3 34.0634.03 14.5cm  
 4 34.0634.04 13.5cm  
 5 34.0634.05 14.0cm  
 6 34.0634.06 13.5cm  
 7 34.0634.07 13.5cm  
 8 34.0634.08 14.0cm  
 9 34.0634.09 13.5cm

Neonatal and Pediatric Clamps, Delicate Pattern  
 Neonatal-und Kinderklemmen, Extrafeine Modelle  
 Pinzas clamps para recién nacidos y pediátricos muy delicados  
 Зажимы с атравматической нарезкой, Зажимы детские  
 新生儿和儿科线夹，玲珑模式



ALSO AVAILABLE IN TITANIUM



34.0640.01  
13.0cm

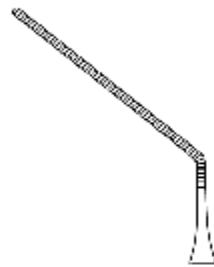

34.0640.02  
13.0cm

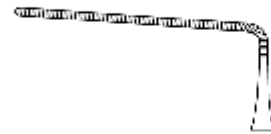

34.0640.03  
11.0cm



CASTANEDA



34.0642.01  
12.0cm



34.0642.02  
12.0cm

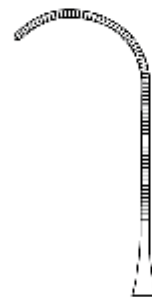

34.0642.03  
12.0cm



34.0642.04  
12.0cm

CARDIOVASCULAR



**JAVID**  
34.0650.18 18.0cm

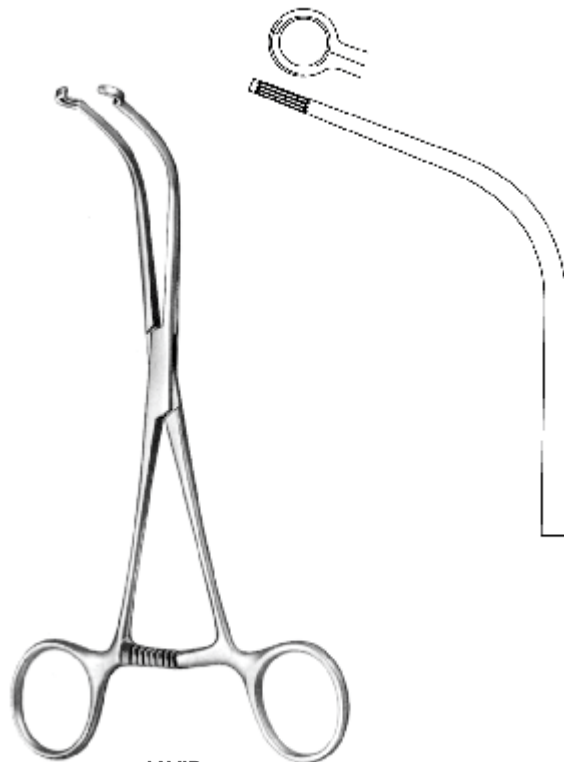

**JAVID**  
34.0650.19 19.0cm

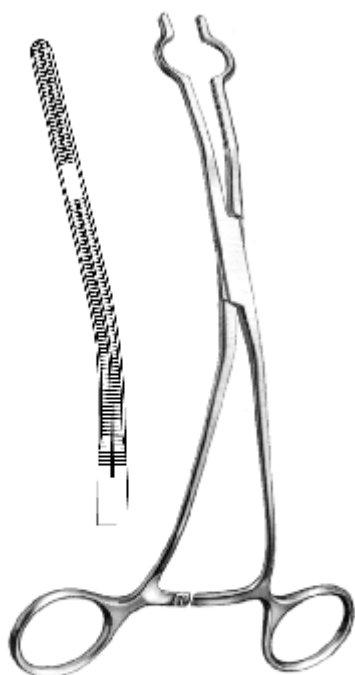

**COOLEY**

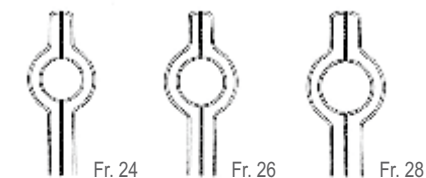

34.0654.01 16.0cm    34.0654.02 16.0cm    34.0654.03 20.0cm

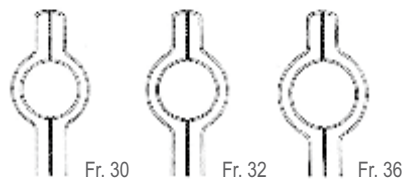

34.0654.04 20.0cm    34.0654.05 20.0cm    34.0654.06 20.0cm

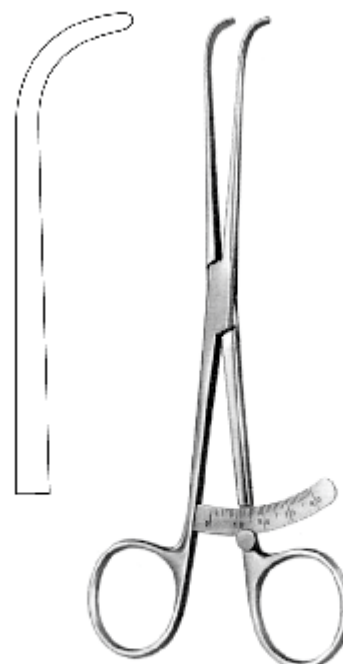

34.0660.18 18.0cm

Universal Clamps  
Mehrzweckklemmen  
Pinze universali  
Зажимы с атравматической нарезкой, Зажимы универсальные  
通用夹具



ALSO AVAILABLE IN TITANIUM

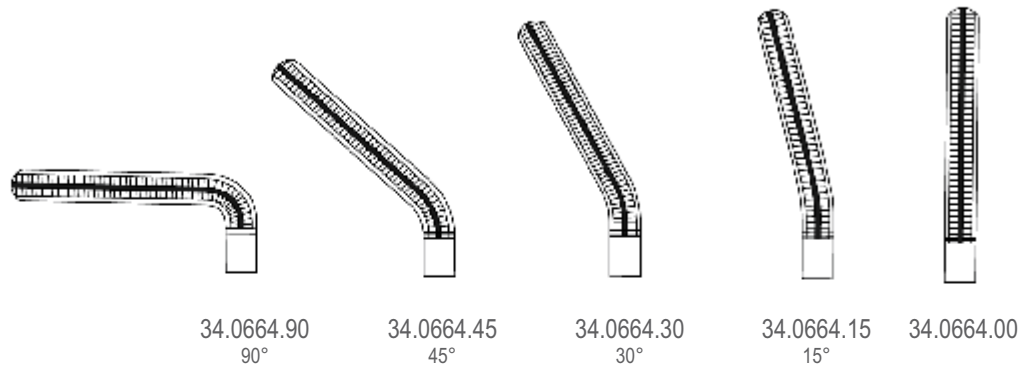

CARDIOVASCULAR

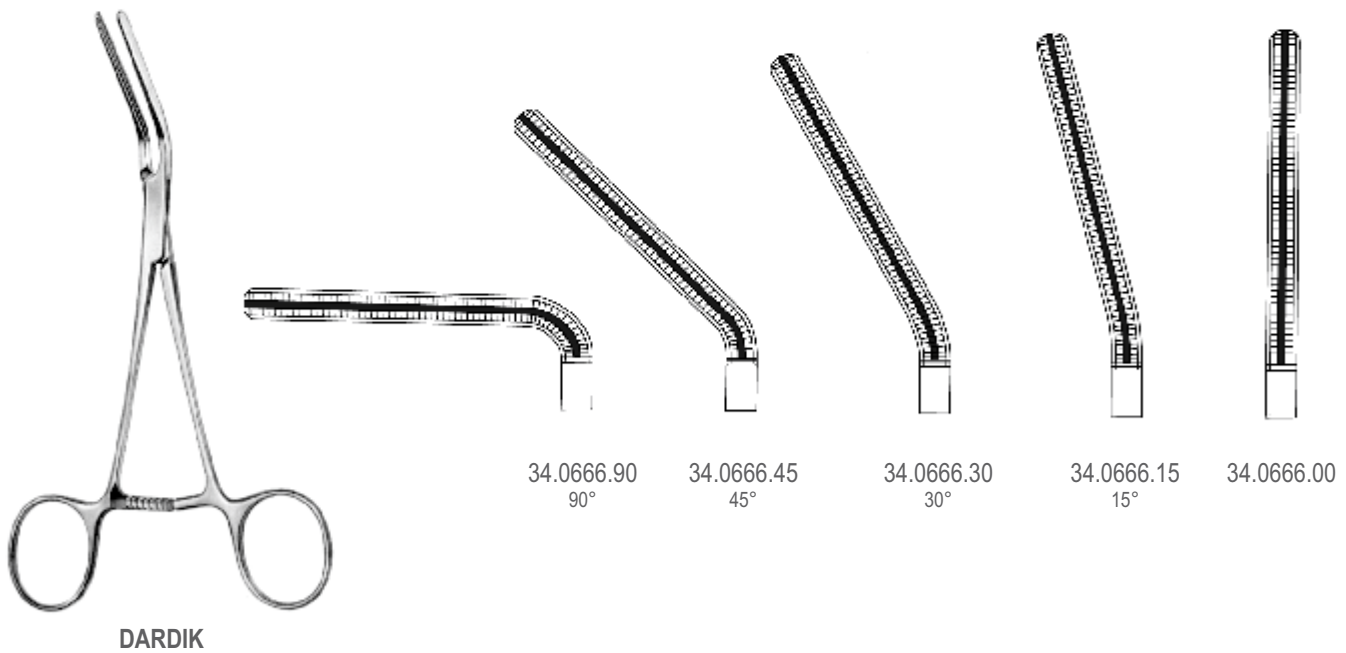

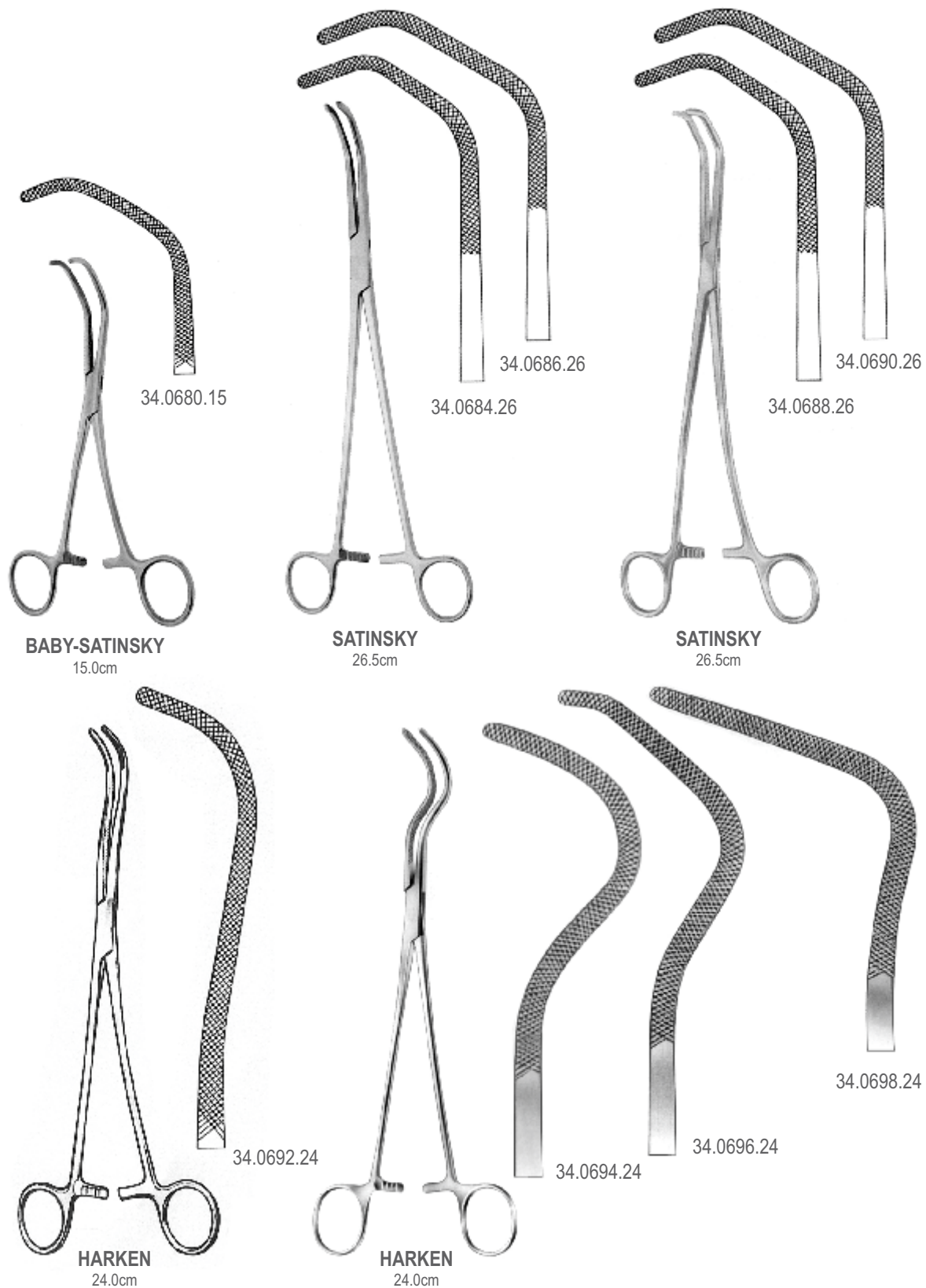

34.0680.15

34.0686.26

34.0690.26

34.0684.26

34.0688.26

**BABY-SATINSKY**  
15.0cm

**SATINSKY**  
26.5cm

**SATINSKY**  
26.5cm

34.0692.24

34.0694.24

34.0696.24

34.0698.24

**HARKEN**  
24.0cm

**HARKEN**  
24.0cm

Lung Grasping Forceps, Aorta Clamps  
 Pinzas-Clamps p/pulmón, Clamps aorta  
 Lungenfasszangen, Aortaklemmen  
 Зажимы для легкого, Зажимы для аорты  
 龙抓钳, 主动脉夹



LOVELACE  
 34.0710.20 20.0cm

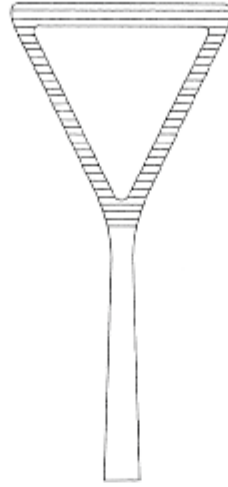

LOVELACE  
 34.0711.20 20.0cm

CARDIOVASCULAR



BLALOCK

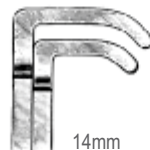

34.0720.14 15.0cm

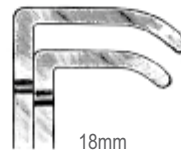

34.0722.18 20.0cm

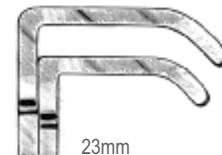

34.0722.23 20.0cm

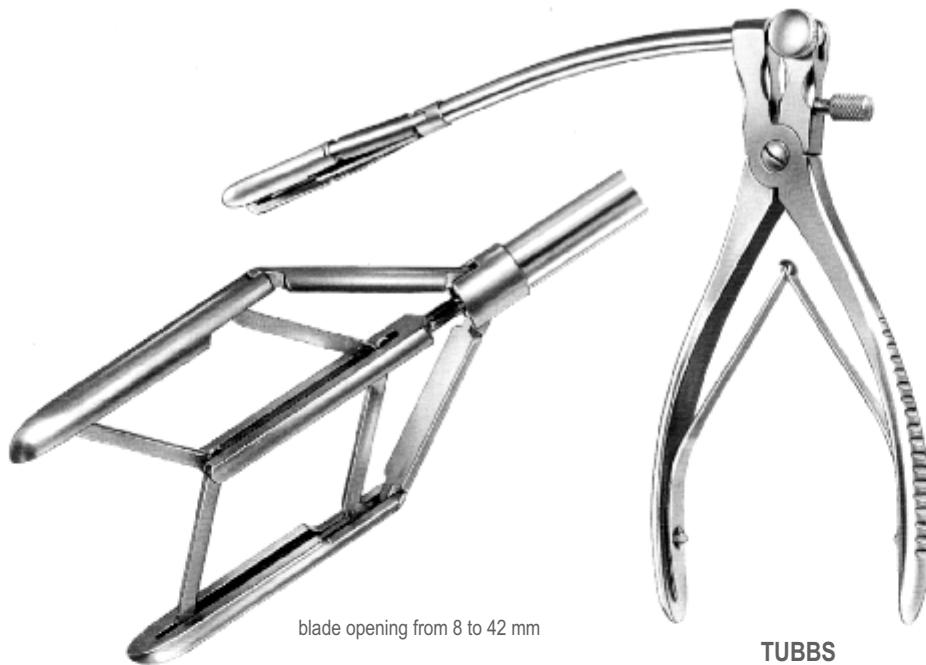

blade opening from 8 to 42 mm

**TUBBS**  
34.0740.42

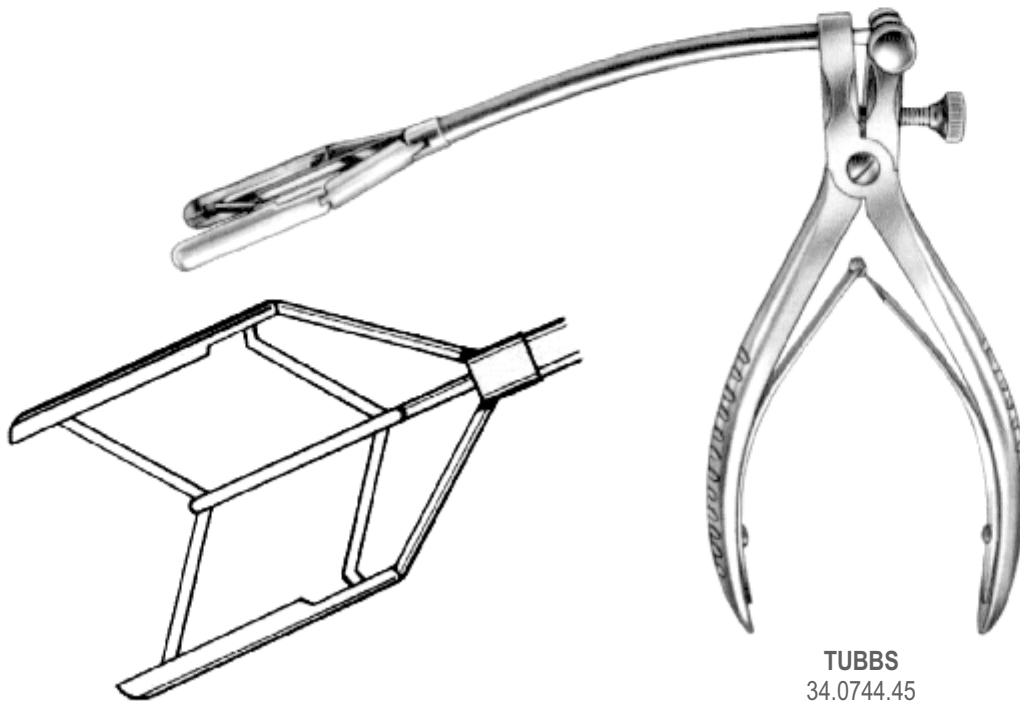

blade opening from 9 to 45 mm

**TUBBS**  
34.0744.45

Vascular Dilators  
Gefäß-Dilatoren  
Dilatadores vasculares  
Расширители сосудистые  
血管扩张器

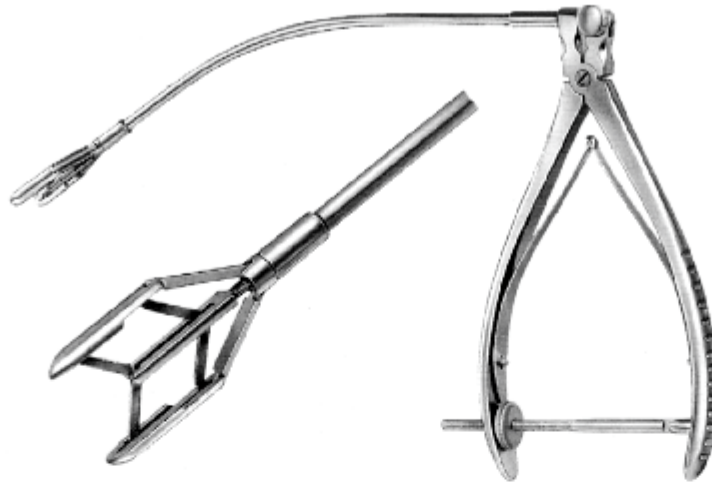

blade opening from 8 to 15 mm  
blade opening from 8 to 45 mm

**COOLEY**  
34.0750.15  
34.0750.45

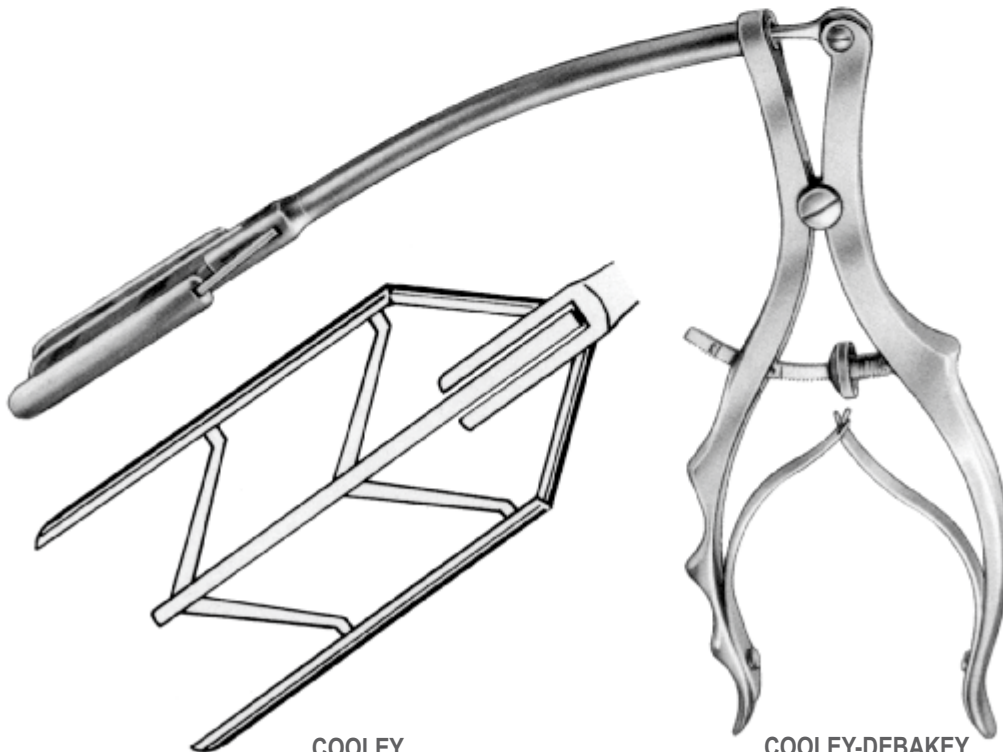

**COOLEY**  
34.0754.40  
blade opening 9 - 40mm

**COOLEY-DEBAKEY**  
34.0756.30  
blade opening 7 - 30mm

CARDIOVASCULAR

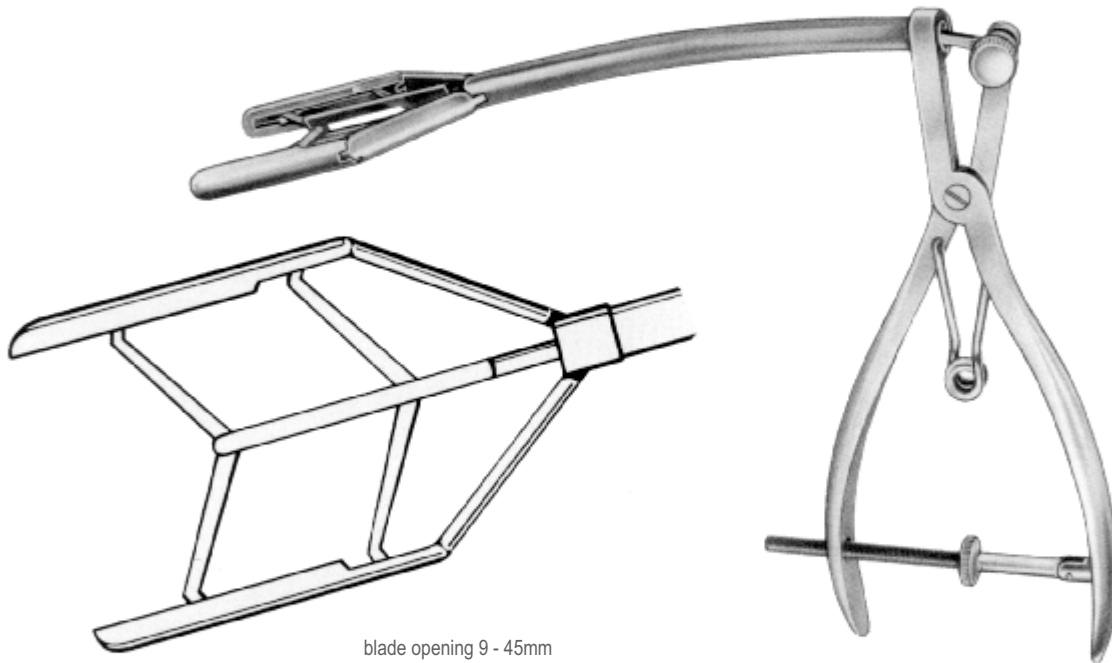

blade opening 9 - 45mm

**GERBODE**  
34.0760.45

Mitral valve Dilators  
Mitral ventil dilatoren  
Dilatadores mitral de válvula  
Расширители сосудистые  
二尖瓣扩张器



Blade opening 4 - 10mm

**HETZER**  
34.0770.10

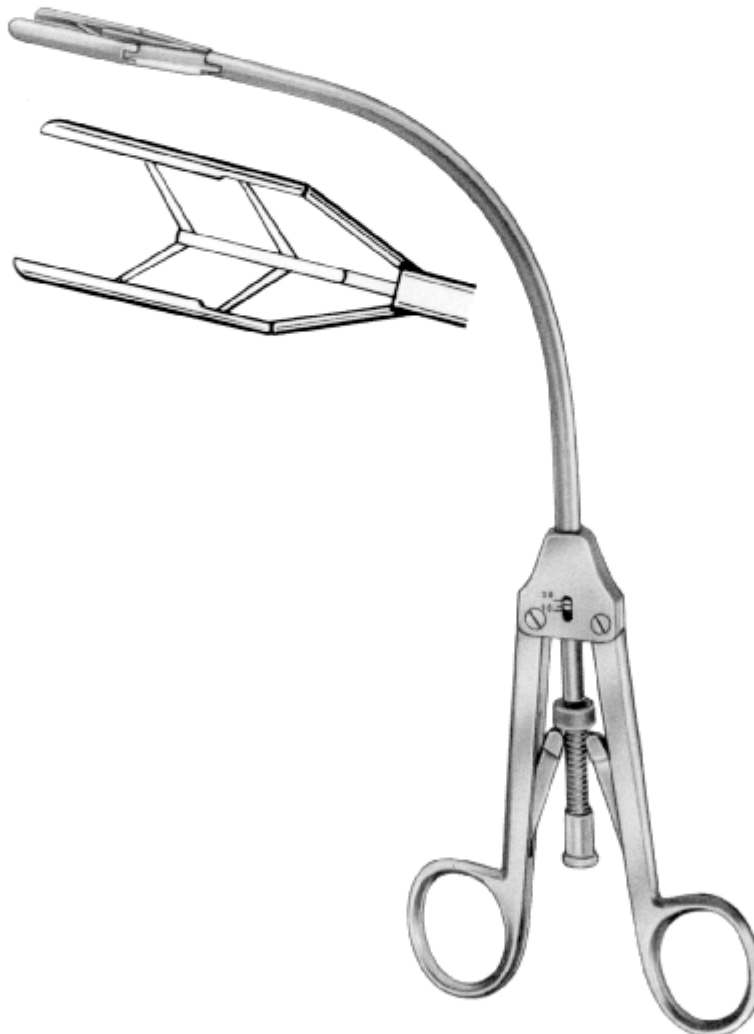

**COOLEY** blade opening  
34.0776.18 5 - 18mm  
34.0776.20 6 - 20mm

CARDIOVASCULAR

CARDIOVASCULAR



**CRILE** 20.0cm  
 34.0780.01  
 34.0780.02

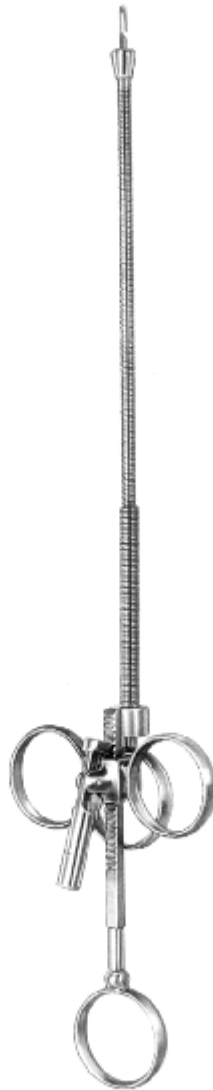

**RUMEL-BELMONT** 33.0cm  
 34.0784.32 3.2mm Ø  
 34.0784.64 6.4mm Ø



26.0cm



34.0786.15  
 1.5mm



34.0786.25  
 2.5mm

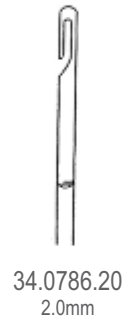

34.0786.20  
 2.0mm



34.0786.30  
 3.0mm



**DE BAKEY**  
 34.0790.50 50.0cm



Enderectomy Spatula and Dilators  
 Endarteriektomie Spachtel und Dilatoren  
 Espátula y dilatadores endarterectomia  
 Шпатели эндерэктомические  
 动脉内膜切除术锅铲和扩张器



CARDIOVASCULAR

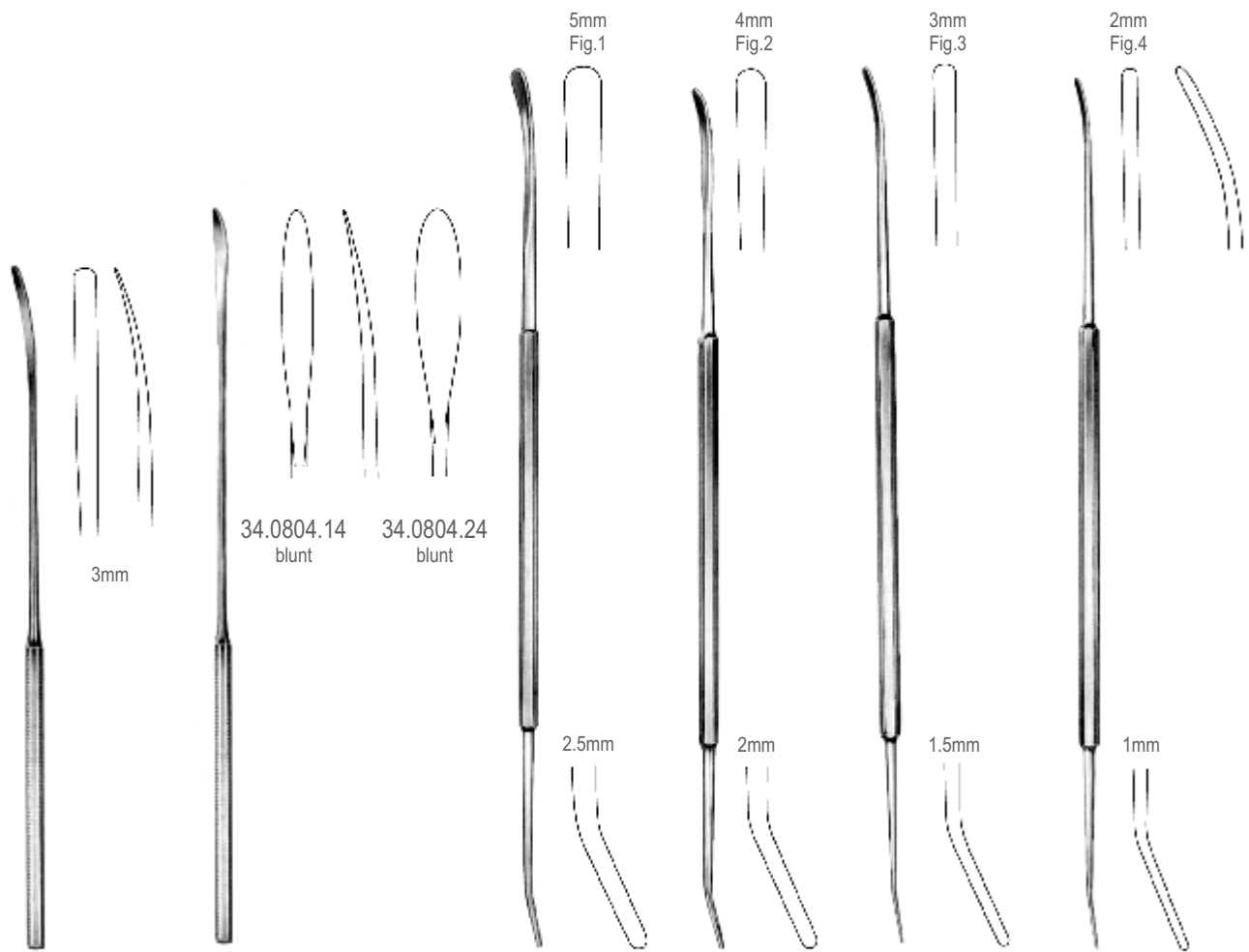

34.0800.18 18.5cm 34.0804.14 14.0cm  
 34.0800.21 21.5cm 34.0804.24 23.5cm

**ROBB**  
 34.0810.01  
 24.0cm

**ROBB**  
 34.0810.02  
 24.0cm

**ROBB**  
 34.0810.03  
 24.0cm

**ROBB**  
 34.0810.04  
 24.0cm

CARDIOVASCULAR



**COOLEY**  
13.0cm

34.0820.05 0.5mm Ø	34.0820.10 1.0mm Ø	34.0820.15 1.5mm Ø	34.0820.20 2.0mm Ø	34.0820.25 2.5mm Ø	34.0820.30 3.0mm Ø	34.0820.40 4.0mm Ø	34.0820.50 5.0mm Ø



**DE BAKEY**

19.0cm 34.0824.05 35.0cm 34.0828.05 0.5mm Ø	34.0824.10 34.0828.10 1mm Ø	34.0824.15 34.0828.15 1.5mm Ø	34.0824.20 34.0828.20 2mm Ø	34.0824.25 34.0828.25 2.5mm Ø	34.0824.30 34.0828.30 3mm Ø
19.0cm 34.0824.35 35.0cm 34.0828.35 3.5mm Ø	34.0824.40 34.0828.40 4mm Ø	34.0824.45 34.0828.45 4.5mm Ø	34.0824.50 34.0828.50 5mm Ø	34.0824.70 34.0828.70 7mm Ø	34.0824.90 34.0828.90 9mm Ø