



THE ULTIMATE CHOICE

## **RHINOLOGY**

Rhinology  
Rhinologie  
Rinologia  
РИНОЛОГИЯ  
鼻科





**VACHER**  
 46.0010.00



**VOLTOLINI**



1 46.0014.01



2 46.0014.02



3 46.0014.03

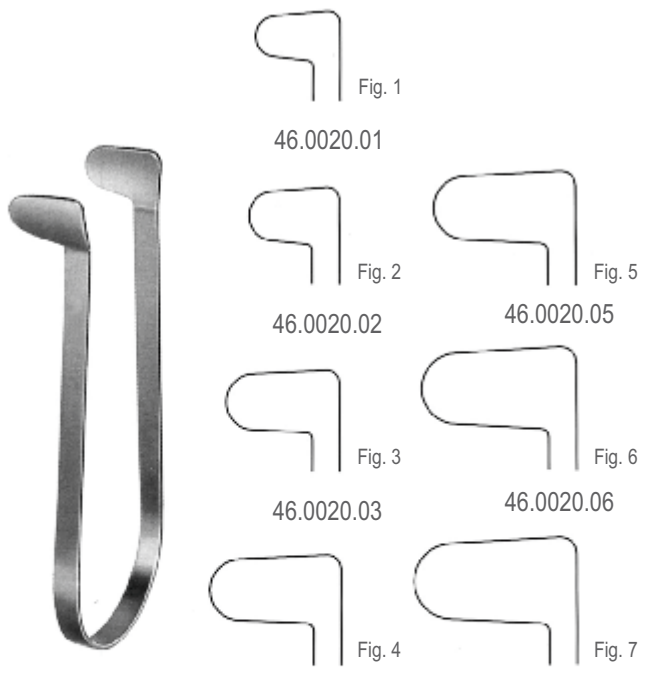

**GOLDSMITH (Thudichum)**  
 46.0020.00 set / 7

Fig. 1  
 46.0020.01

Fig. 2  
 46.0020.02

Fig. 3  
 46.0020.03

Fig. 4  
 46.0020.04

Fig. 5  
 46.0020.05

Fig. 6  
 46.0020.06

Fig. 7  
 46.0020.07

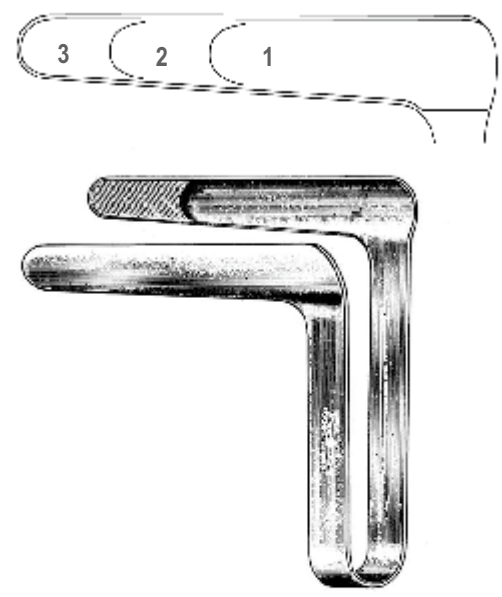

**ST. CLAIR THOMSON**  
 46.0024.00 set / 3  
 46.0024.01 35mm Fig. 1  
 46.0024.02 50mm Fig. 2  
 46.0024.03 75mm Fig. 3

RHINOLOGY

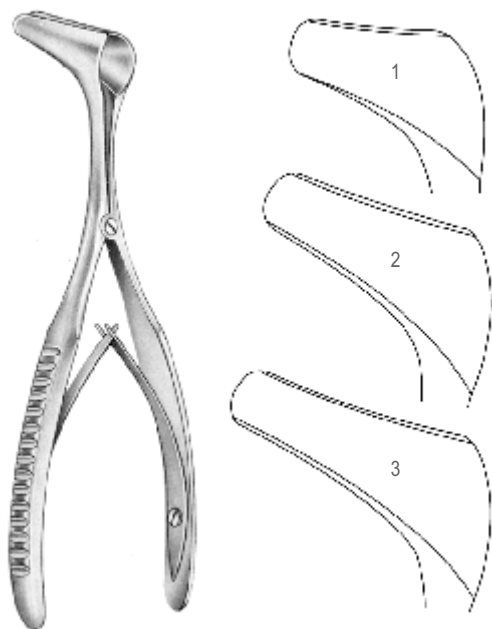

**HARTMANN-HALLE**

15.0cm

- 46.0030.01 Fig. 1
- 46.0030.02 Fig. 2
- 46.0030.03 Fig. 3

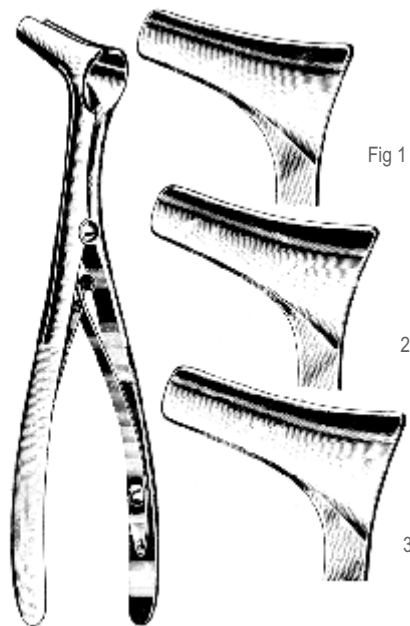

**HARTMANN**

16.5cm

- 46.0032.01 Fig. 1
- 46.0032.02 Fig. 2
- 46.0032.03 Fig. 3

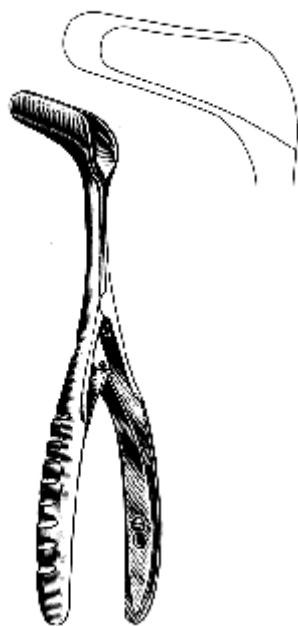

**SCHWARZ**

46.0036.14 14.0cm



**VIENNA**

14.5cm

- 46.0040.01 (infant)
- 46.0040.02 (child)
- 46.0040.03 (adult)
- 46.0040.04 (sheet metal)



**MOD WIEN**

46.0044.14 14.5cm



Pediatrics

46.0048.13 13.0cm



46.0049.13 13.0cm

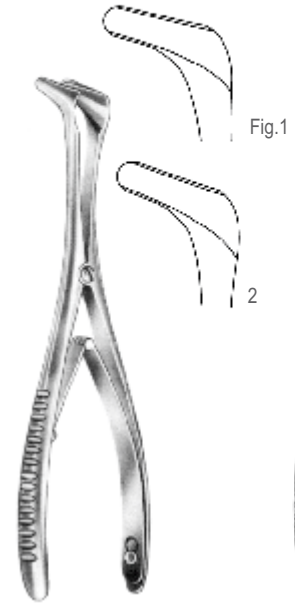

**TIECK-HALLE**  
 13.5cm  
 46.0052.01  
 46.0052.02



**TIECK-HALLE**  
 46.0056.13 13.5cm



**KILLIAN**  
 13.0cm  
 46.0060.35  
 46.0060.50  
 46.0060.75  
 46.0060.90

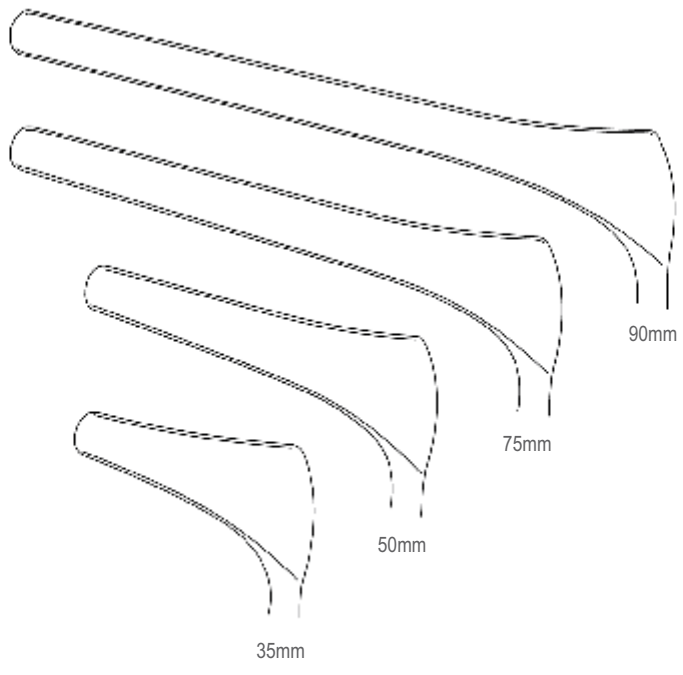

**KILLIAN (with side screw)**  
 13.0cm  
 46.0062.35  
 46.0062.50  
 46.0062.75  
 46.0062.90

RHINOLOGY



**COTTLE**  
15.0cm  
46.0070.35  
46.0070.50  
46.0070.75  
46.0070.90

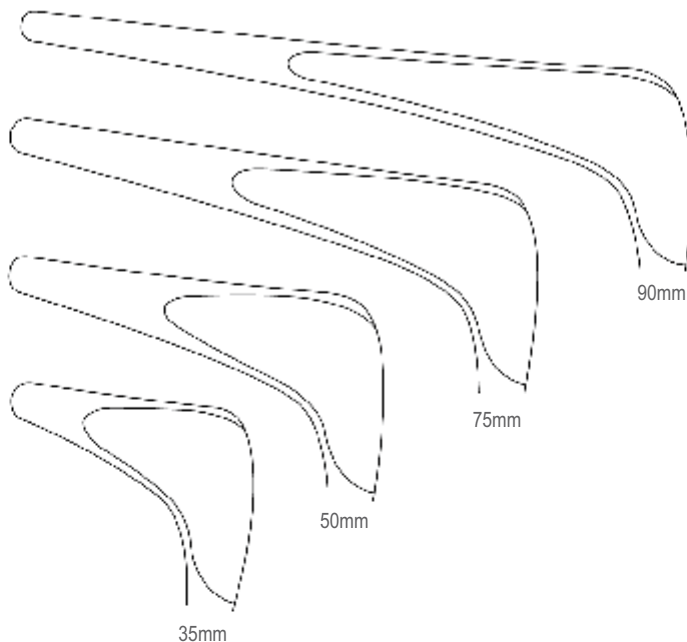

**COTTLE (with side screw)**  
15.0cm  
46.0072.35  
46.0072.50  
46.0072.75  
46.0072.90



**COTTLE**  
(dull black chromium plated)  
14.0cm

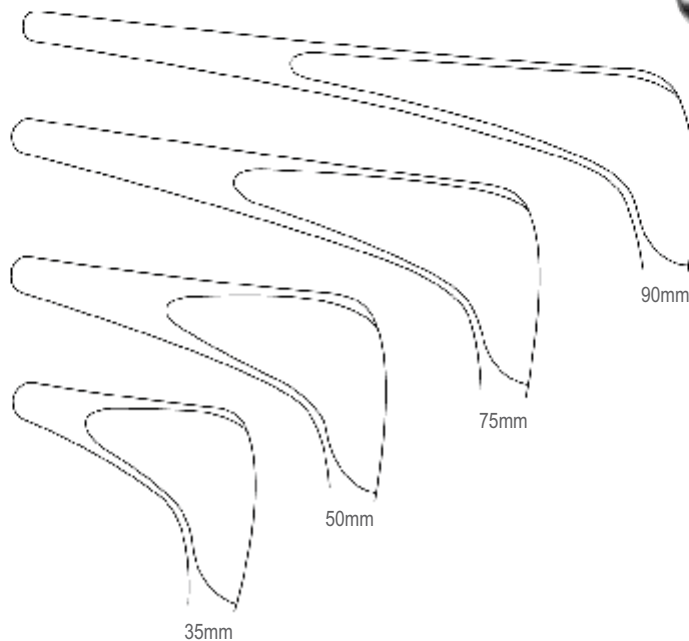

46.0076.35  
46.0076.50  
46.0076.75  
46.0076.90

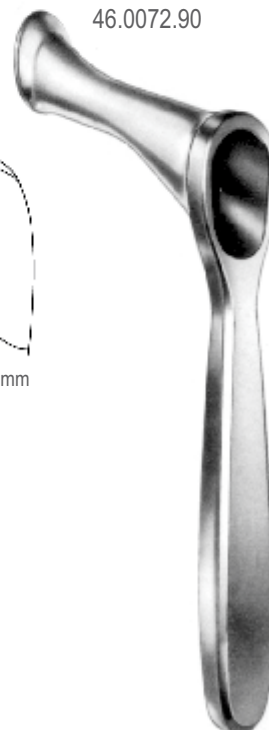

**YANKAUER**  
46.0080.19 19.0cm

Nasal Snares  
 Polypenschnurer  
 Polipotomos  
 Щипцы для полипов  
 鼻息肉圈断器



44.0270.03 0.3mm Ø  
 44.0270.04 0.4mm Ø



44.0274.02 0.2mm Ø  
 44.0274.03 0.3mm Ø



**KRAUSE**  
 46.0100.26 26.0cm

**KRAUSE-VOSS**  
 46.0104.26 26.0cm

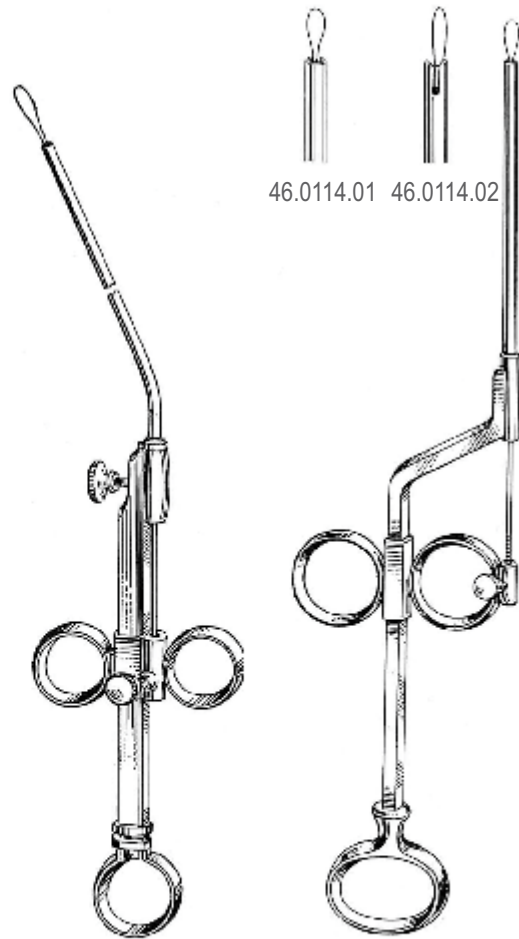

46.0114.01 46.0114.02

**KRAUSE**  
 46.0110.00

**GLEGG**

RHINOLOGY



**KILLIAN**  
46.0120.17 17.0cm



**LITTAUER**  
46.0124.18 18.0cm

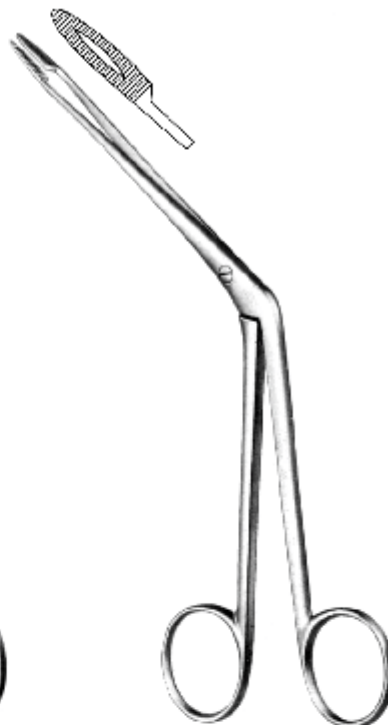

**HARTMANN**  
46.0130.20 20.0cm



**QUIRE**  
46.0134.12 12.0cm

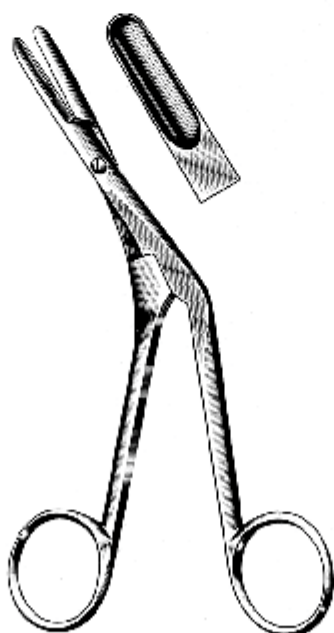

**GRAIG**  
46.0140.18 18.0cm



46.0144.01 46.0144.02

18.0cm

Nasal Polypus and Septum Compression Forceps  
 Polypenzangen, Septumzange  
 Pinzas para polipos, pinzas para el tabique nasal  
 Щипцы для перевязочного материала и тампонов  
 鼻息肉和鼻中隔压缩钳



**KNIGHT**  
46.0150.18 18.0cm

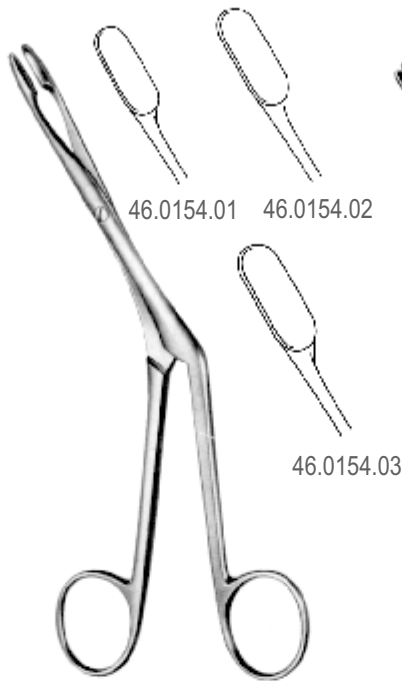

**HEYMANN**  
18.0cm

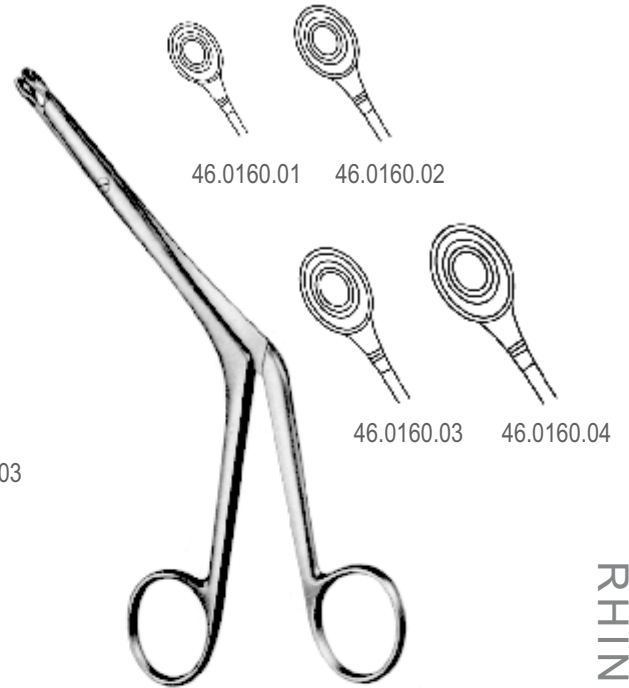

**BRUENINGS**  
19.0cm

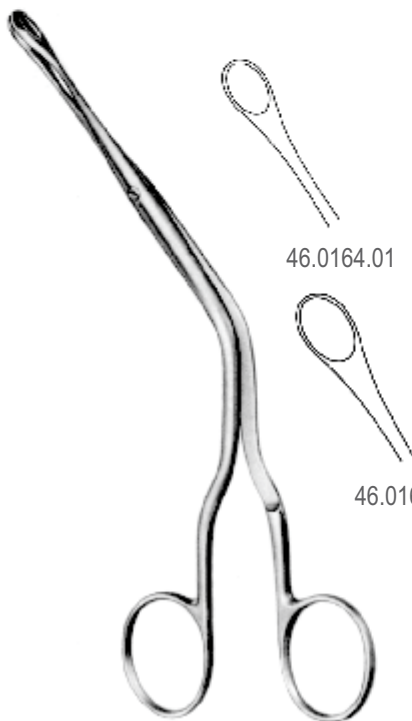

**LUC**  
20.0cm

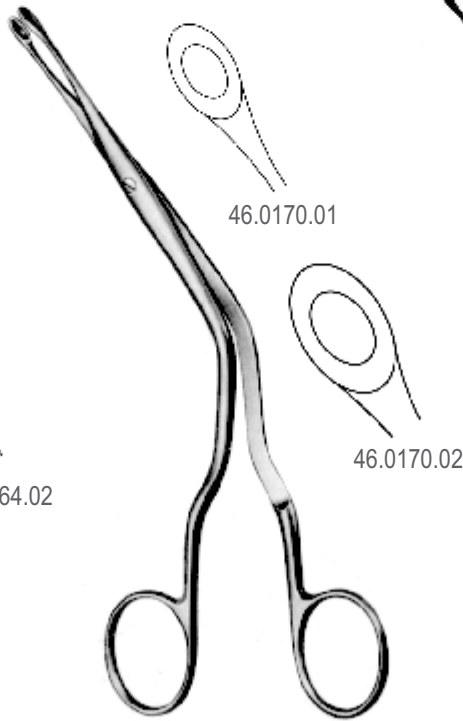

**LUC**  
20.0cm

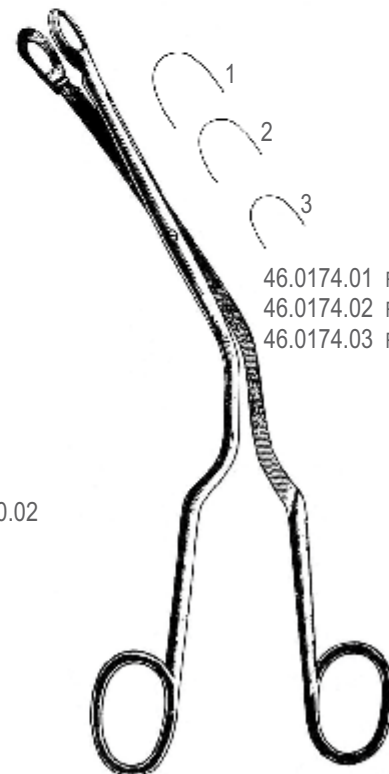

**LUC**  
20.0cm

46.0174.01 Fig. 1  
46.0174.02 Fig. 2  
46.0174.03 Fig. 3

RHINOLOGY

Dressing and Tampon Forceps, Nasal Polypus Forceps

Tamponpinzetten und-zangen, Polypenzangen

Pinzas para compresas y taponamientos, pinzas para pollipos

Щипцы для перевязочного материала и тампонов, Пинцеты, Щипцы для полипов

修整和凹凸钳，鼻息肉钳

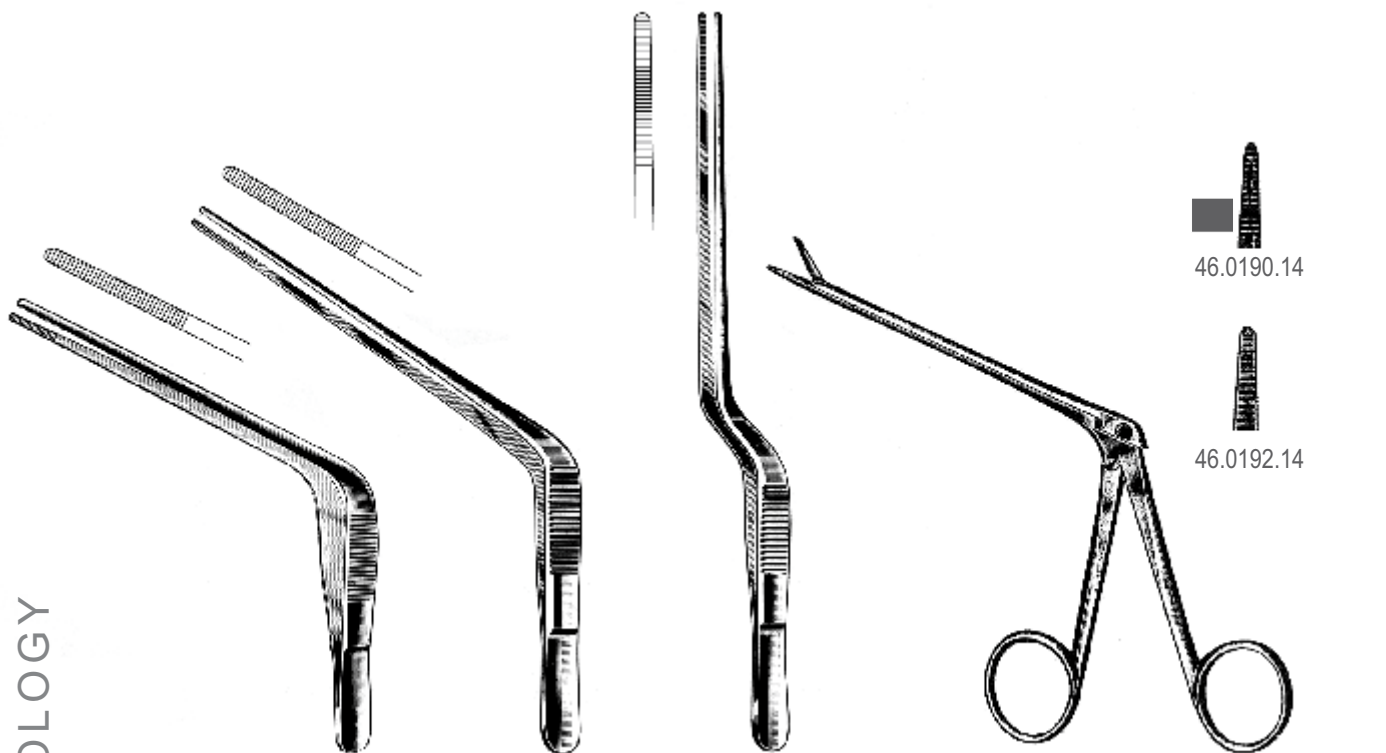

**TROELTSCH**  
46.0180.15 15.0cm

**TROELTSCH**  
46.0182.18 18.0cm

**GRUENWALD (JANSEN)**  
46.0186.16 16.0cm  
46.0186.20 20.0cm

**NOYES**  
14.5cm



RHINOLOGY



**WESTMACOTT**  
46.0196.20  
20.0cm

**LUBET-BARBON**  
46.0200.20  
20.0cm

**HARTMANN**  
46.0204.16  
16.0cm

**HEYMANN-KNIGHT**  
46.0210.18  
18.0cm

Nasal Cutting Forceps  
 Scharfe Nasenzangen  
 Pinzas cortantes cara la nariz  
 Щипцы носовые режущие  
 鼻切割钳

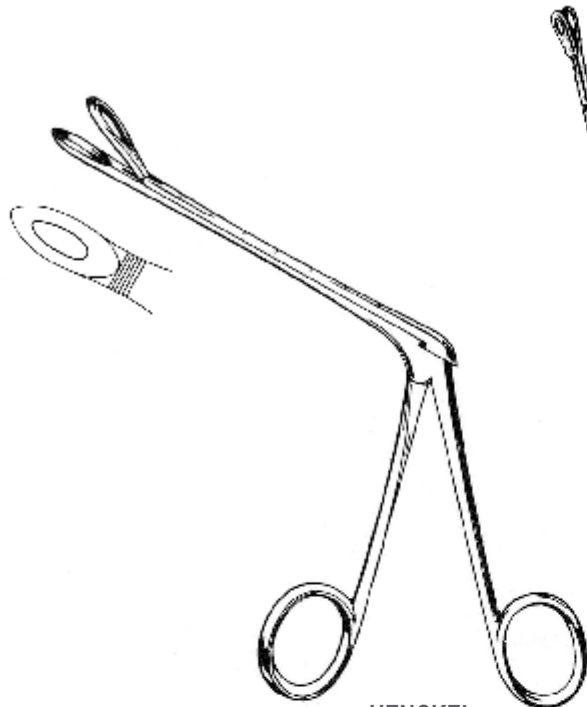

**HENCKEL**  
 46.0214.20 20.0cm

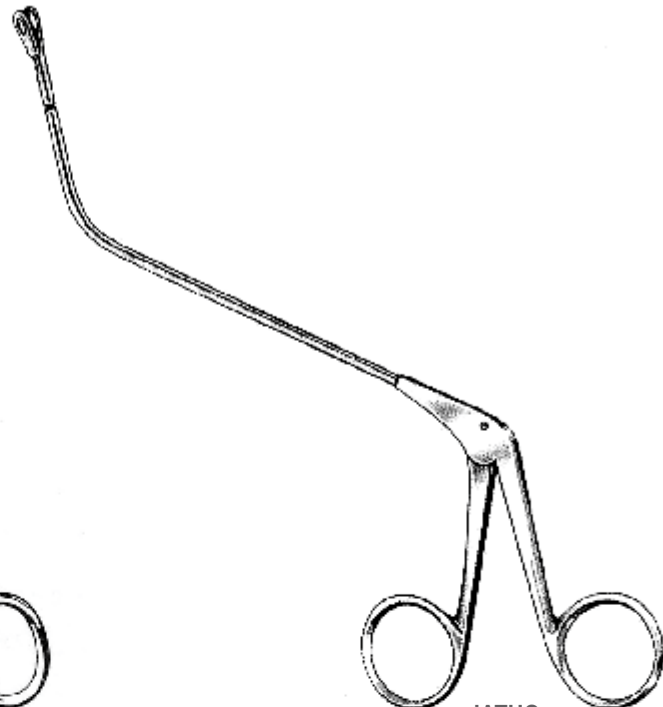

**JATHO**  
 46.0220.15 24.0cm

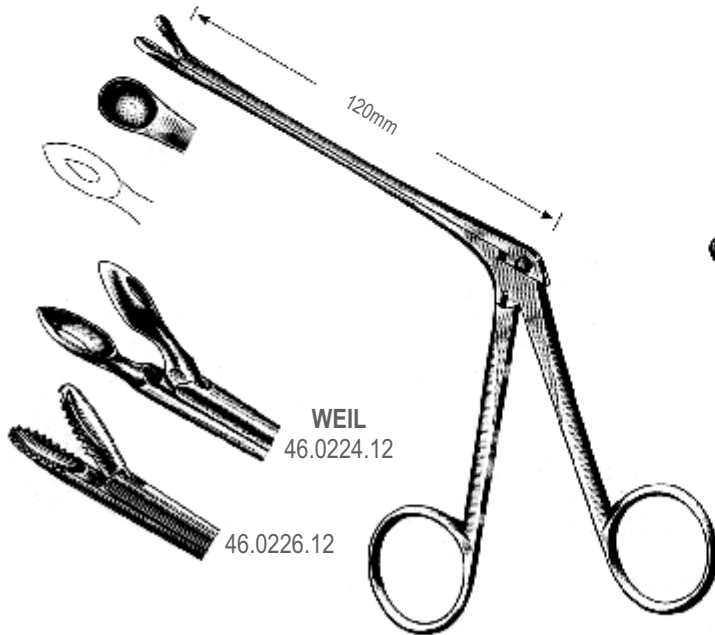

**WATSON-WILLIAMS**  
 46.0222.12 19.0cm

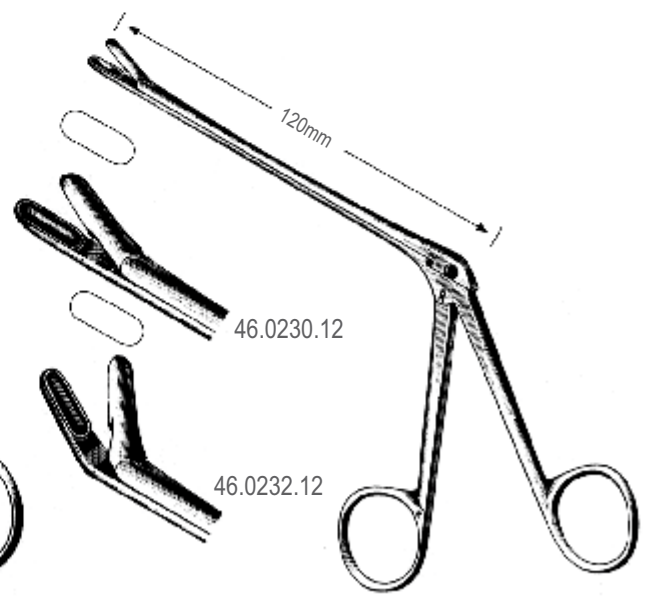

**TAKAHASHI**  
 19.0cm

RHINOLOGY

Nasal Cutting Forceps  
Scharfe Nasenzangen  
Pinzas cortantes para la nariz  
Щипцы носовые режущие  
鼻切割钳

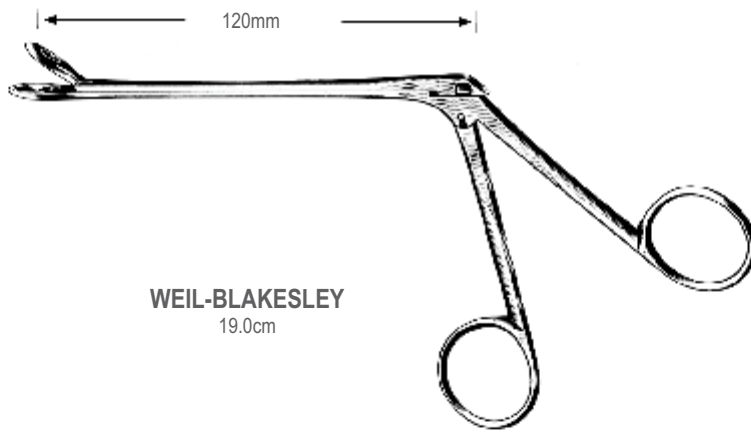
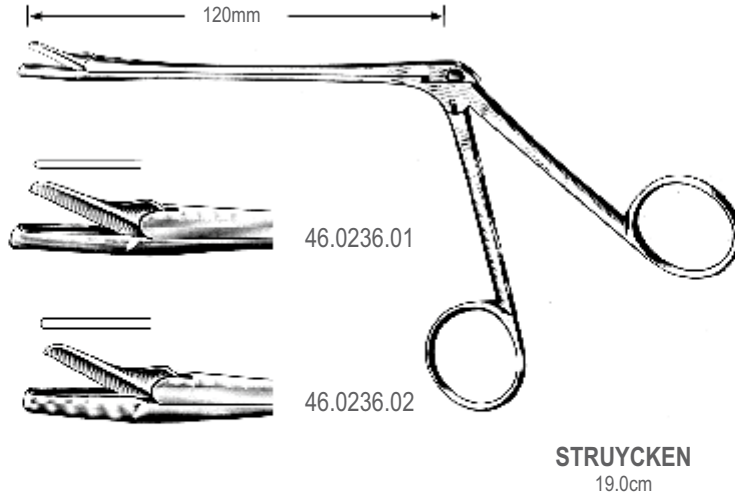

RHINOLOGY

Nasal Cutting Forceps  
 Scharfe Nasenzangen  
 Pinzas cortantes cara la nariz  
 Щипцы носовые режущие  
 鼻切割钳

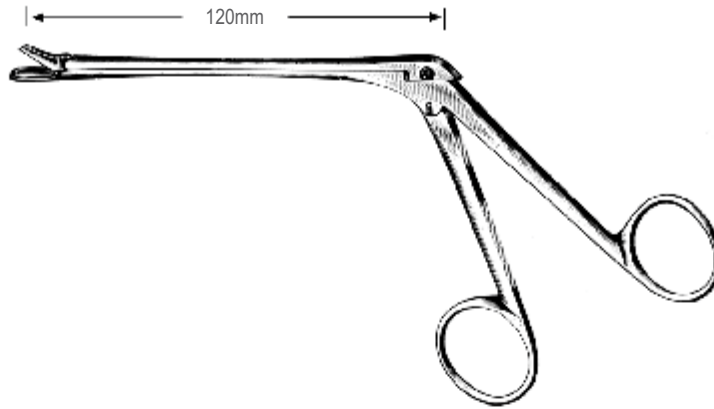

**HAJEK**  
19.0cm

46.0250.12



**SCHMEDEN**  
19.0cm

46.0254.12



**HARTMANN**  
19.0cm

46.0260.01  
5mm

46.0260.02  
7mm

46.0260.03  
9mm

46.0260.04  
11mm



**MYLES**  
19.0 cm

46.0264.01  
2.2mm

46.0264.02  
2.6mm

46.0270.01  
5mm

46.0270.02  
7mm

46.0264.03  
3mm

46.0264.04  
3.4mm

46.0270.03  
9mm

RHINOLOGY

Sphenoid Punches and Rongeur Forceps  
 Keibeinstanzen, Meibelzangen  
 Pinzas cortantes para seno esfenoidal, pinzas-gubias  
 Выкусыватели оториноларингологические  
 蝶窦冲头和咬骨钳

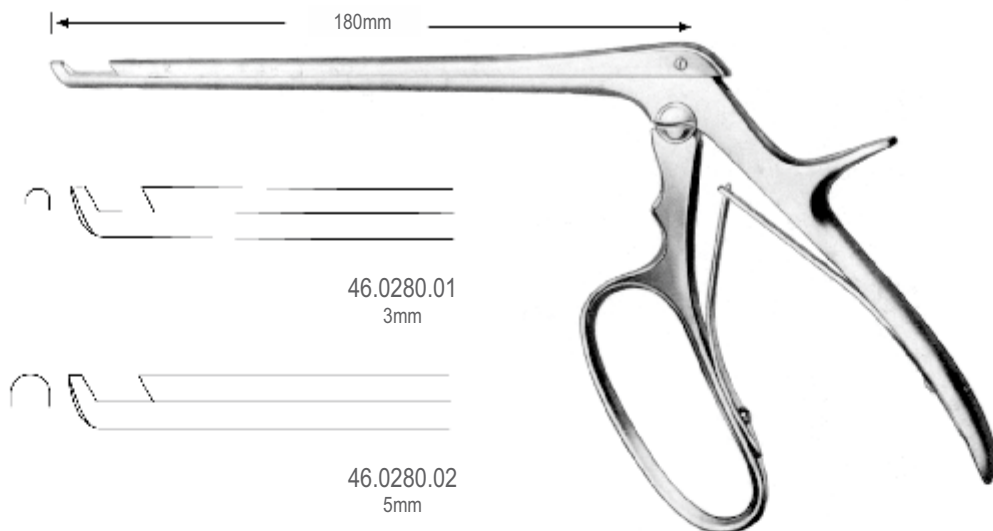

**FERRIS-SMITH-KERRISON  
(CLOWARD HARPER)**

RHINOLOGY

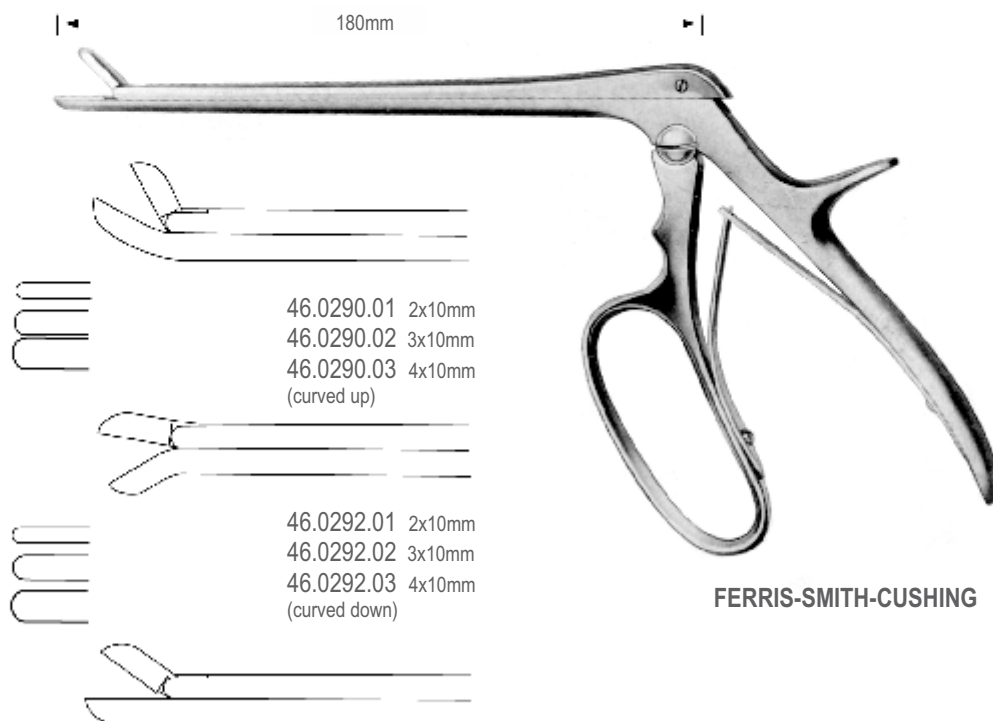

**FERRIS-SMITH-CUSHING**



Sphenoid Punches, Antrum Punch Forceps  
 Keibeinstanzen, Kieferhohlenstanzen  
 Pinzas cortantes para seno esfenoidal y maxilar  
 Выкусыватели оториноларингологические  
 蝶窦冲床, 冲床鼻窦镊

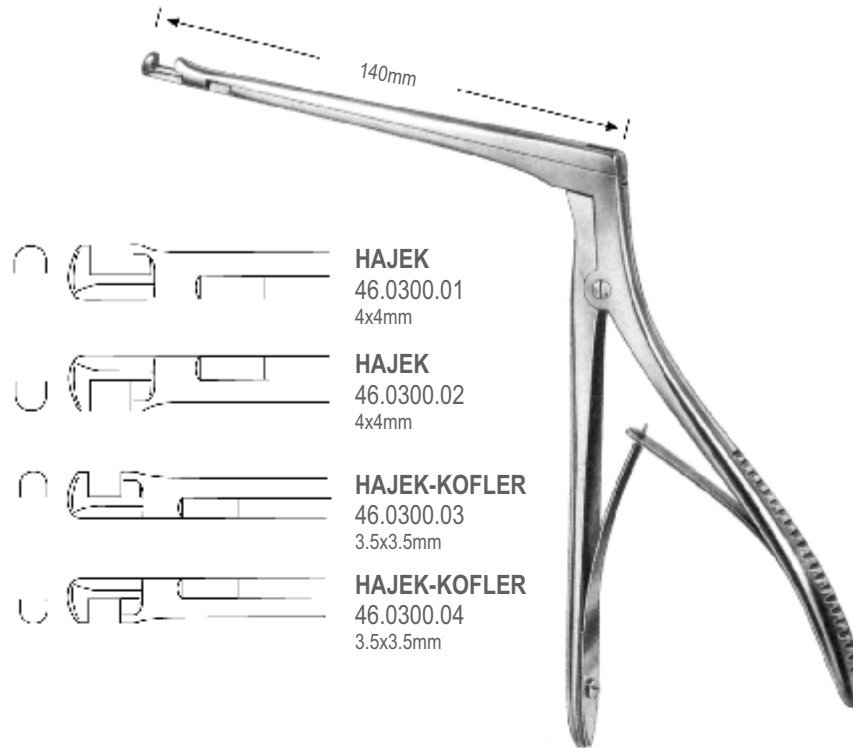

**HAJEK**  
 46.0300.01  
 4x4mm

**HAJEK**  
 46.0300.02  
 4x4mm

**HAJEK-KOFLER**  
 46.0300.03  
 3.5x3.5mm

**HAJEK-KOFLER**  
 46.0300.04  
 3.5x3.5mm

RHINOLOGY

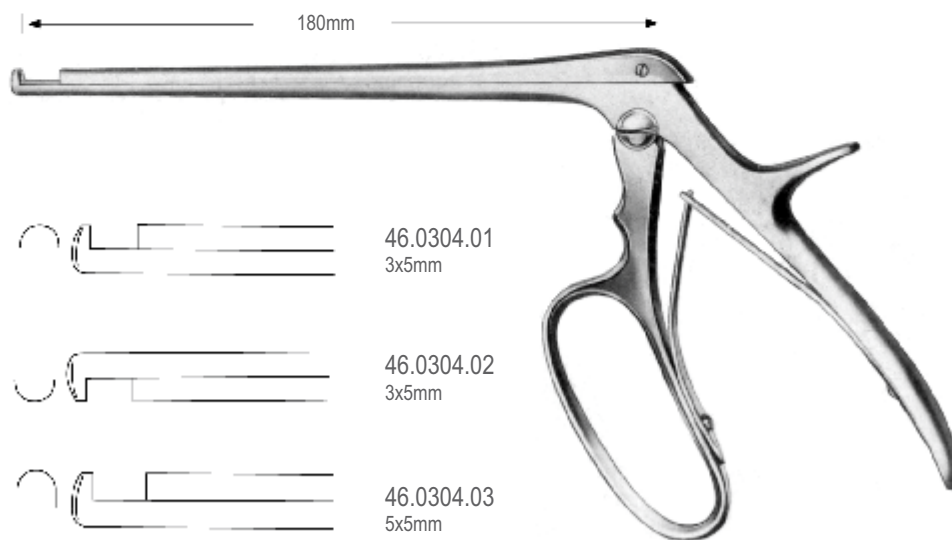

46.0304.01  
 3x5mm

46.0304.02  
 3x5mm

46.0304.03  
 5x5mm

46.0304.04  
 5x5mm

FERRIS-SMITH-KERRISON

Sphenoid Punches, Antrum Punch Forceps  
 Keilbeinstanzen, Kieferhohlenstanzen  
 Pinzas cortantes para seno esfenoidal y maxilar  
 Выкусыватели оториноларингологические  
 蝶窦冲床，冲床鼻窦镊

RHINOLOGY

- 4x4mm  46.0310.01  
4mm
- 5x5mm  46.0310.02  
5mm
- 6x6mm  46.0310.03  
6mm



**KERRISON**  
20.0cm



**HAJEK-CLAUS**  
46.0312.20 20.0cm



**CITELLI**  
 46.0314.10 1mm  
 46.0314.25 2.5mm  
 46.0314.30 3mm  
 46.0314.35 3.5mm  
 46.0314.40 4mm



**BEYER**  
46.0316.19 2mm



**BEYER**  
46.0318.19 1mm

Septum Compression Forceps, Septum Scissors  
 Septumzangen, Septumscheren  
 Pinzas para el tabique nasal, tijares para el tabique nasal  
 Щипцы носовые, Ножницы оториноларингологические  
 隔压钳, 剪刀隔

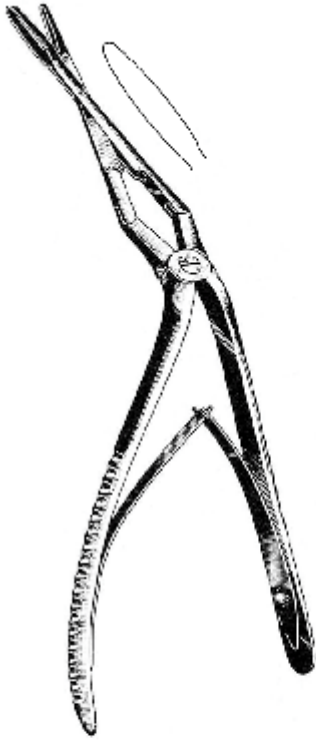

**JANSEN-STRUYCKEN**  
 46.0320.19 19.0cm



**MIDDLETON-JANSEN**  
 46.0322.19 19.0cm



**MIDDLETON-JANSEN**  
 46.0324.19 19.0cm



**CAPLAN**  
 46.0330.20  
 20.0cm

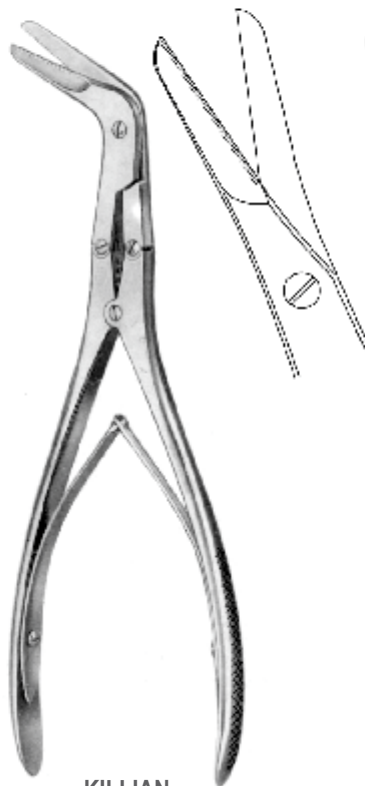

**KILLIAN**  
 46.0334.21  
 21.0cm



**RUBIN**  
 46.0340.21  
 21.0cm

RHINOLOGY

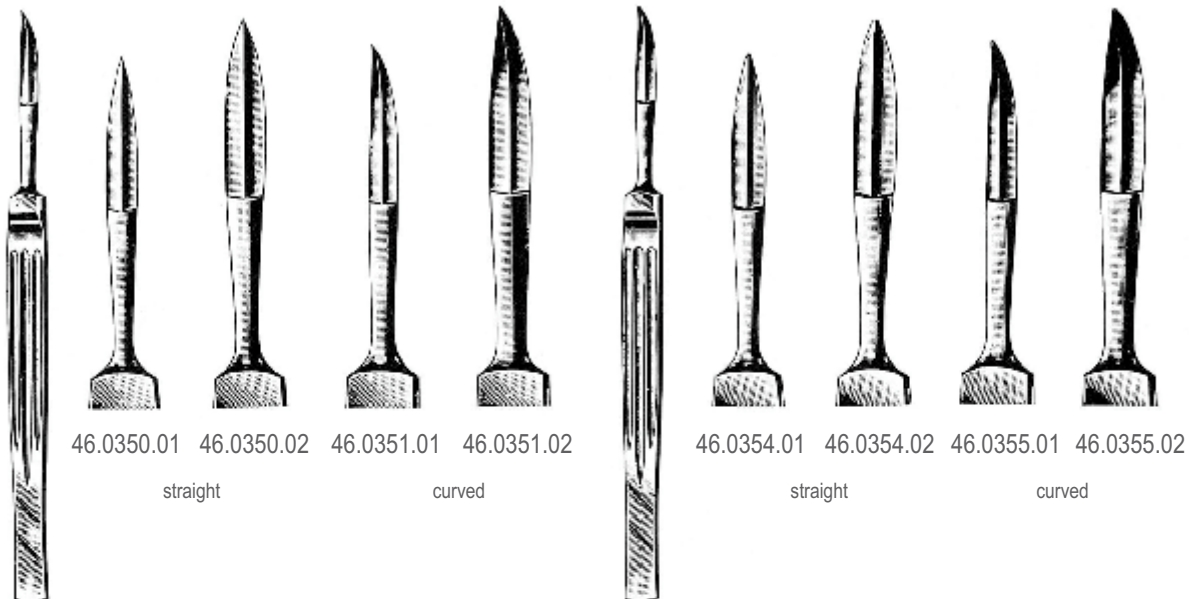

46.0350.01 46.0350.02 46.0351.01 46.0351.02

straight curved

46.0354.01 46.0354.02 46.0355.01 46.0355.02

straight curved

**JOSEPH (sharp)**  
15.0cm

**JOSEPH (blunt)**  
15.0cm

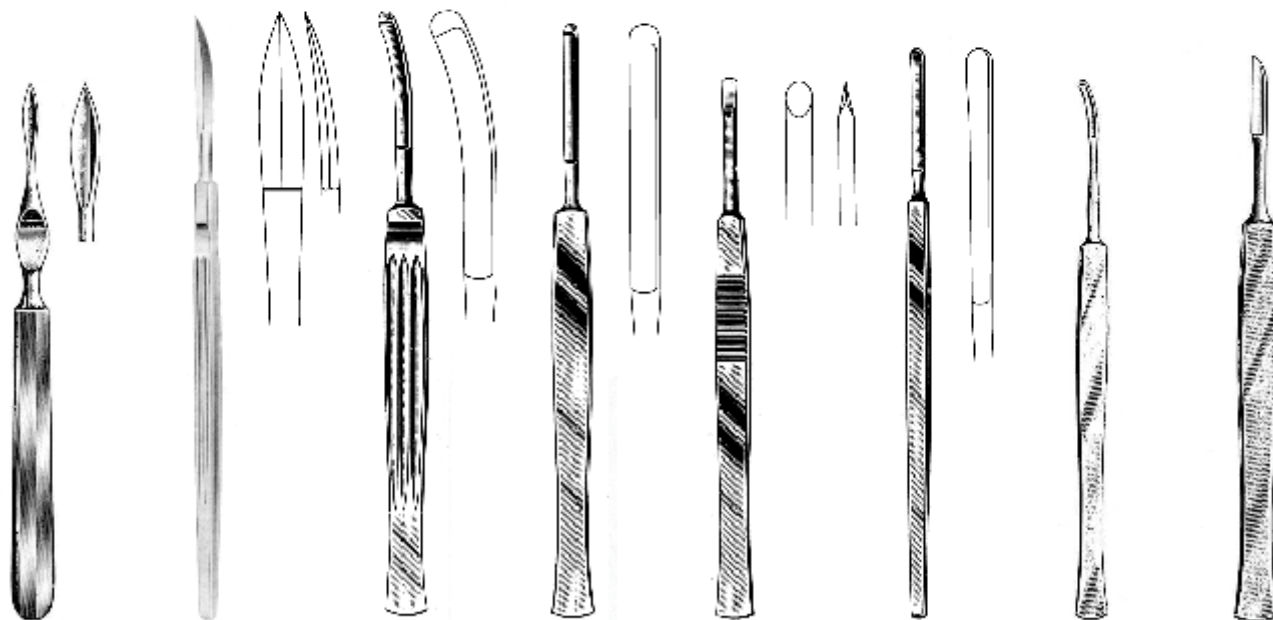

**BALLENGER**  
46.0360.00

**FOMON**  
46.0364.16  
16.0cm

**CONVERSE**  
46.0370.16  
16.0cm

**JOSEPH**  
46.0374.15  
15.0cm

**COTTLE**  
46.0380.15  
15.0cm

**COTTLE**  
46.0384.15  
15.0cm

**HEYMANN**  
46.0390.00

**KRIEG**  
46.0394.00

Septum Knife, Mucous Knives, Swivel Knives  
 Septummesser, Mukosamesser, Schwingmesser  
 Cuchillo para el tabique nasal, la mucosa, cuchillos y hojas movibles  
 Ножи оториноларингологические, Ножи для носовой перегородки  
 刀粘液, 旋转刀



**BALLENGER**  
20.0cm

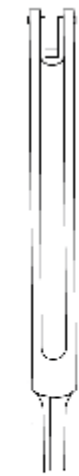

46.0400.03  
3mm



46.0400.04  
4mm



46.0400.05  
5mm



**BALLENGER**  
20.0cm



46.0401.03  
3mm



46.0401.04  
4mm



46.0401.05  
5mm



**BRUENINGS**  
46.0404.16 16.5cm



**FREER**  
46.0406.00



**FREER**  
46.0408.15  
15.0cm

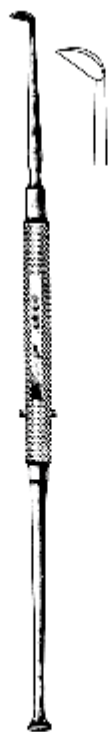

**FREER**  
46.0410.19  
19.0cm

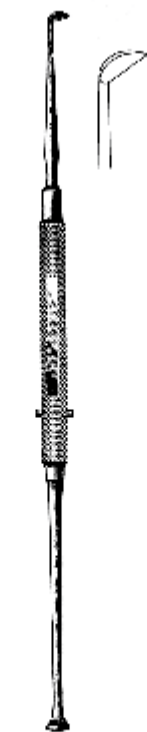

**FREER**  
46.0412.19  
19.0cm



**FREER**  
46.0414.19  
19.0cm



**FREER**  
46.0416.19  
19.0cm

RHINOLOGY

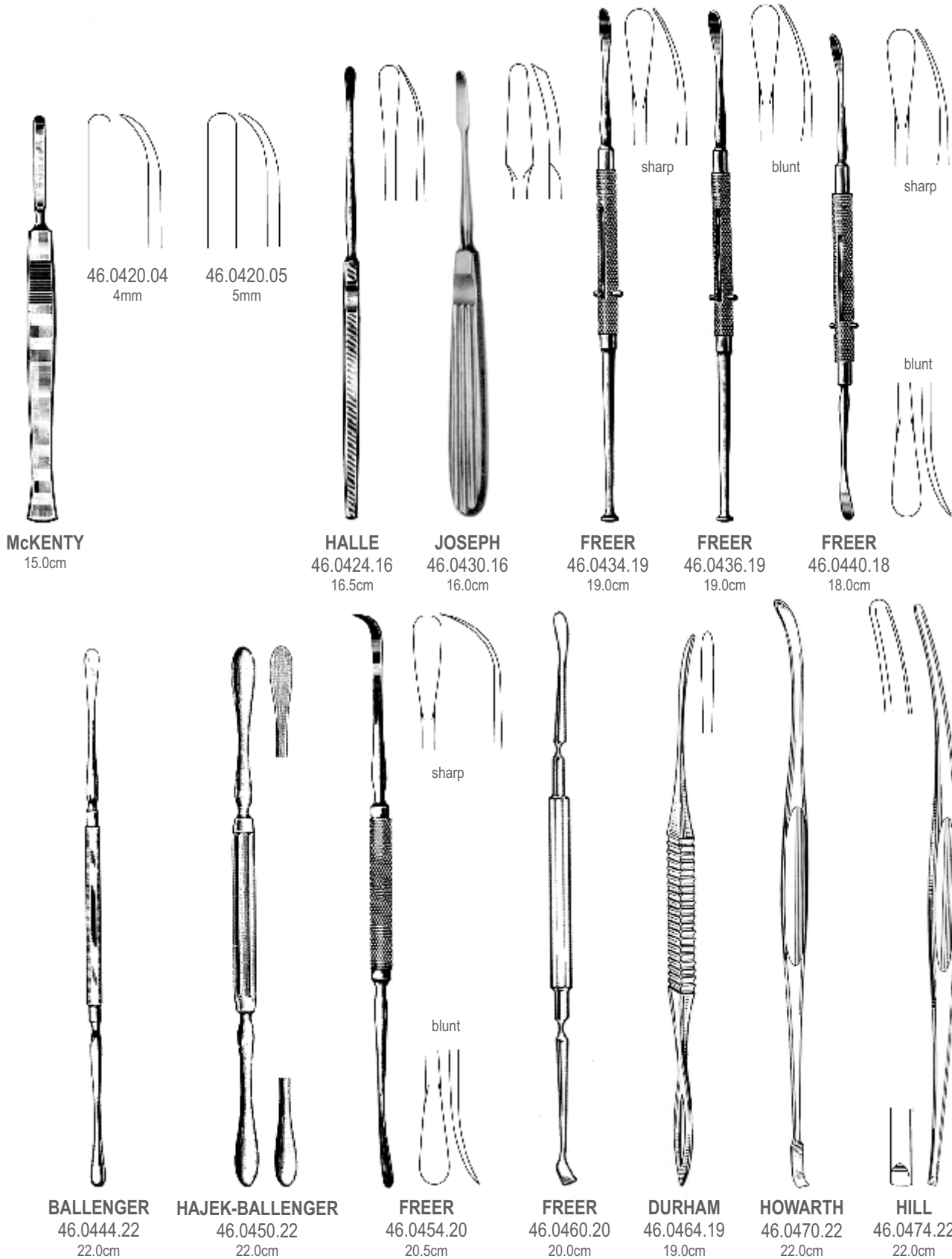

Septum and Periosteal Elevators  
 Septum-und Periost-Elevatoren  
 Elevadores para el tabique nasal y para el periostia  
 Элеваторы оториноларингологические  
 隔膜和骨膜电梯

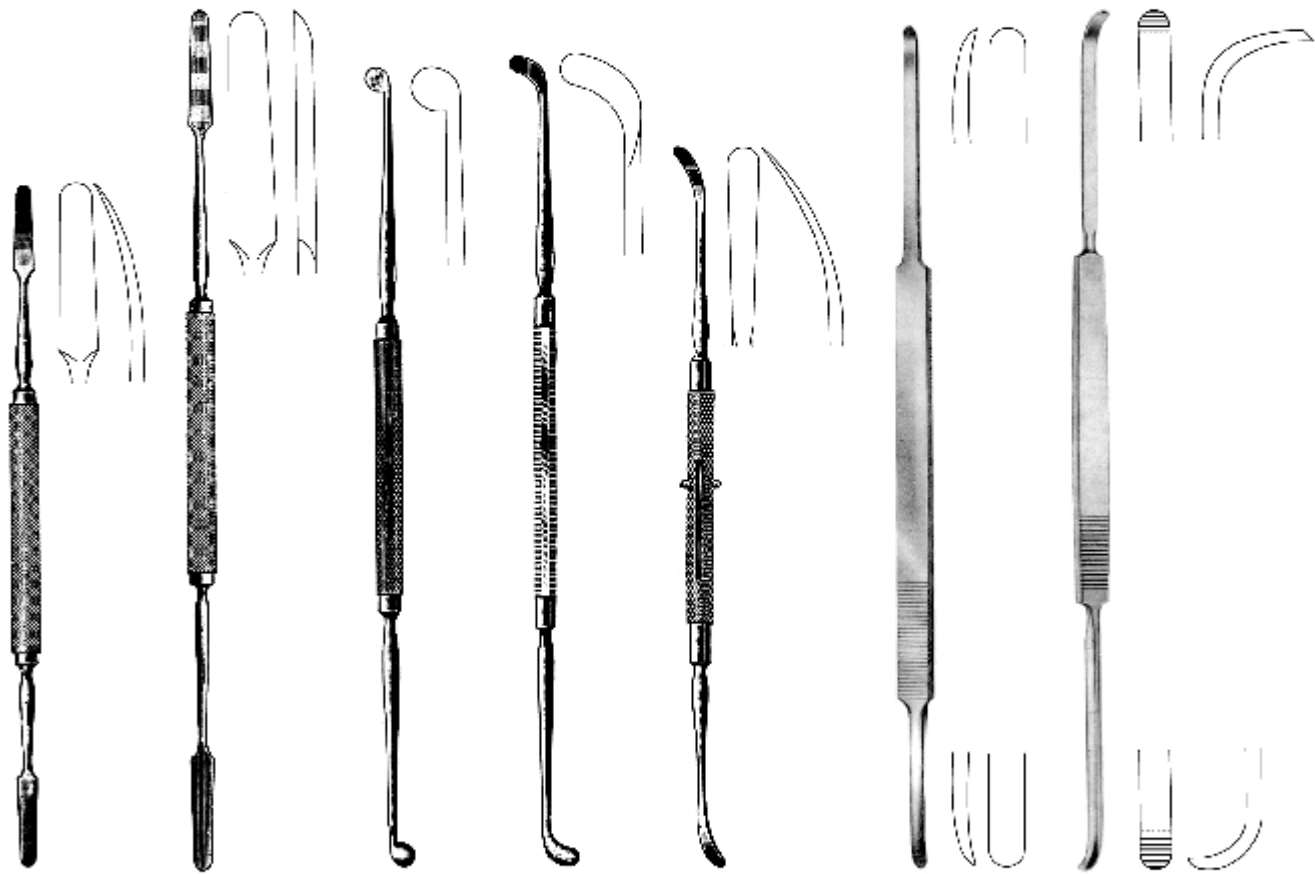

**KILLIAN**  
 46.0480.18  
 18.0cm

**KILLIAN**  
 46.0484.22  
 22.0cm

**PIERCE**  
 46.0490.21  
 21.0cm

**PENNINGTON**  
 46.0494.21  
 21.0cm

**ROGER**  
 46.0500.19  
 19.0cm

**McKENTY**  
 46.0504.22  
 22.0cm

**COTTLE**  
 46.0510.23  
 23.0cm

RHINOLOGY

RHINOLOGY



**MASING**  
46.0514.21  
21.0cm



**CARTER**  
46.0520.21  
21.0cm

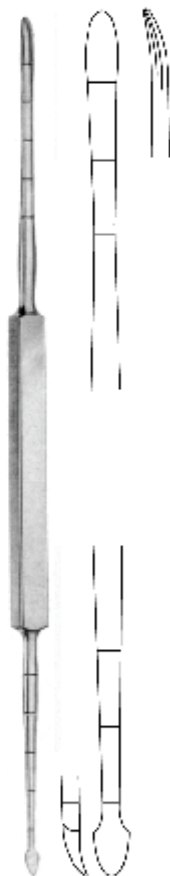

**COTTLE**  
46.0524.21  
21.0cm



**COTTLE**  
46.0530.22  
22.0cm



**JOSEPH**  
46.0534.16  
16.0cm



**COTTLE**  
46.0540.19  
19.0cm



**JOSEPH-MASING**  
46.0544.22  
22.0cm

Septum Gouges, Chisels  
 Septum-Hohlmeißel, -Meißel  
 Gubias y cinceles para tabique nasal  
 Долота оториноларингологические  
 凿子



**KILLIAN**  
 46.0550.17 17.0cm



**KILLIAN-CLAUS**  
 46.0554.17 17.0cm

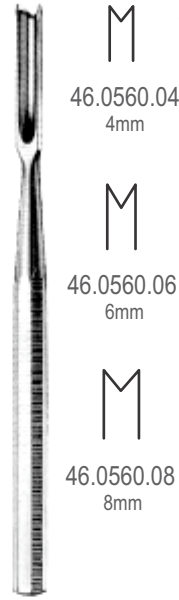

**BALLENGER**



**FREER**  
 46.0564.15  
 15.0cm



**WEST**  
 46.0570.16 16.0cm



**WEST**  
 46.0572.16 16.0cm

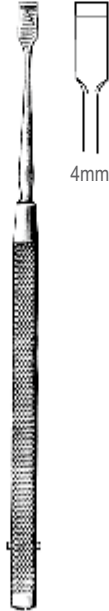

**FREER**  
 46.0580.16



**FREER**  
 46.0582.16

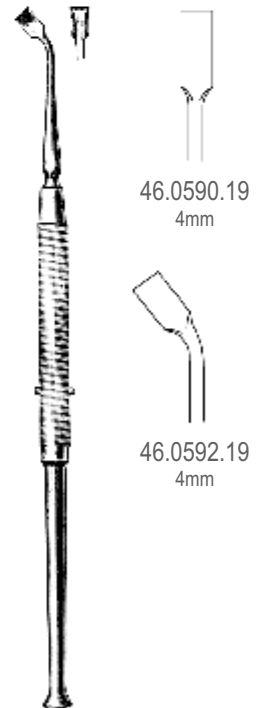

**FREER**

RHINOLOGY

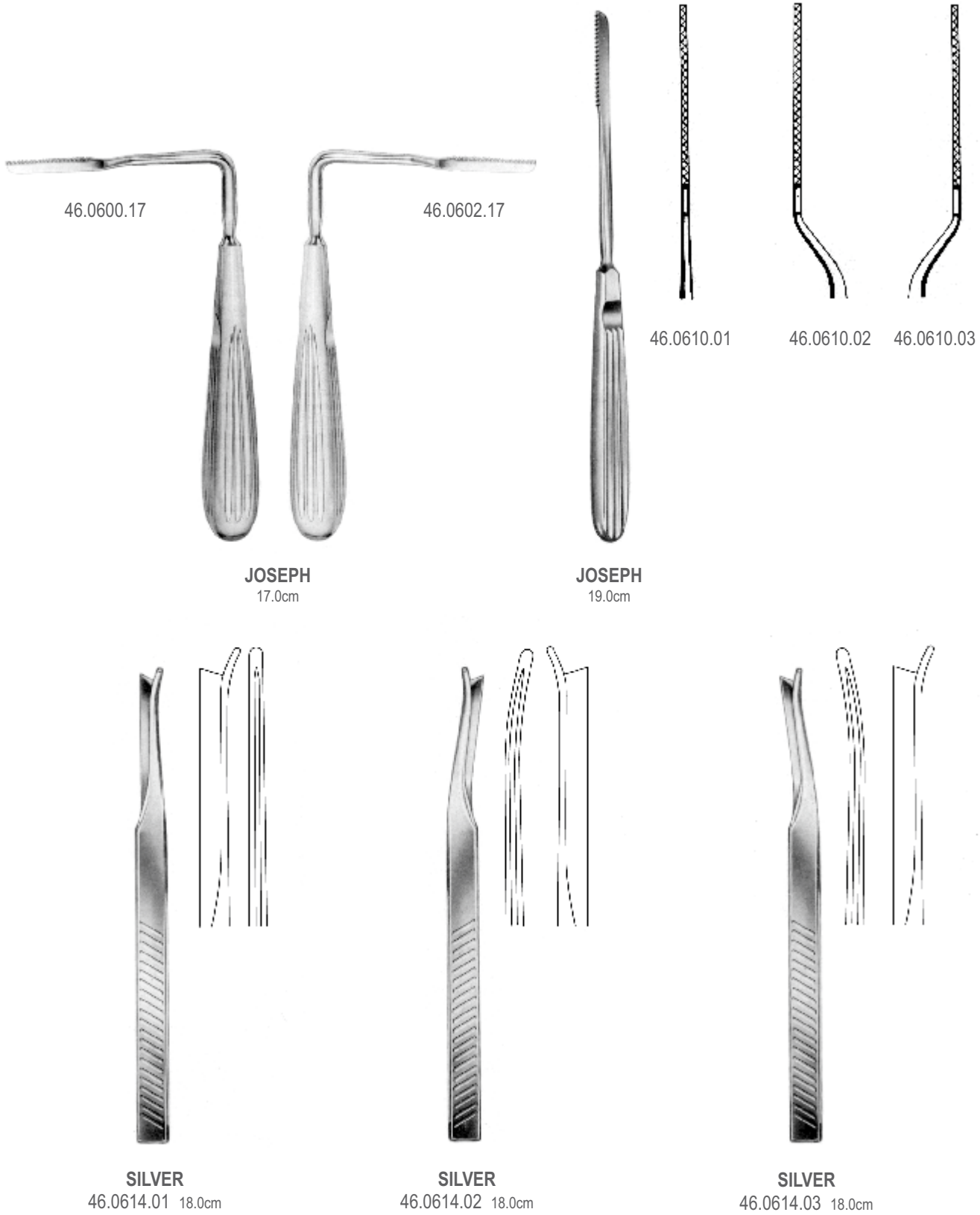

Osteotomes, Gouges, Chisels  
 Osteotome, Hohlmeißel, Meißel  
 Osteótomos, gubias, cinceles  
 Долота оториноларингологические  
 骨凿



**COTTLE**  
 46.0621.18 18.0cm



**COTTLE**  
 18.0cm



**COTTLE**  
 46.0624.18 18.0cm



**COTTLE**  
 46.0623.18 18.0cm

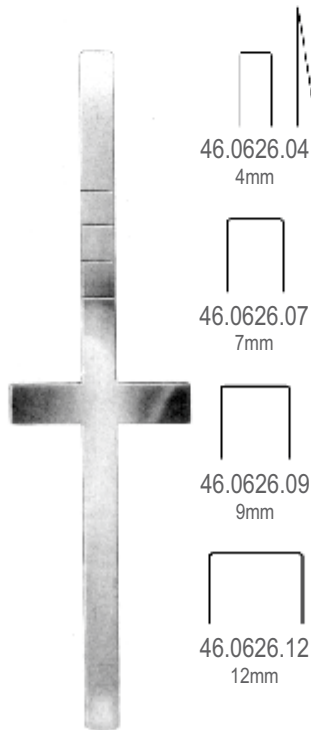

**COTTLE**  
 18.0cm



**COTTLE**  
 46.0628.18 18.0cm

RHINOLOGY

RHINOLOGY

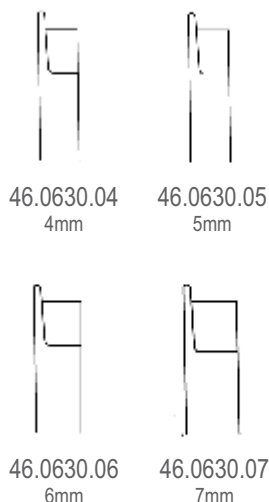

**FOMON**  
17.0cm

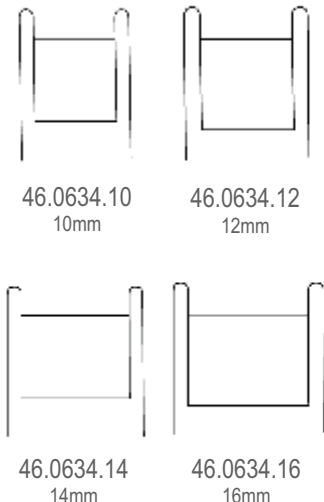

**CINELLI**  
16.0cm

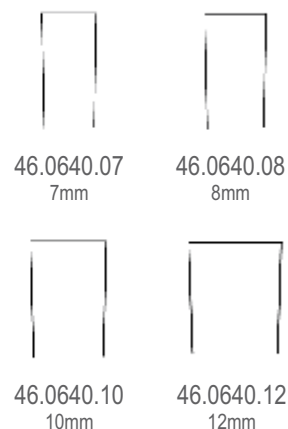

**SHEEHAN**  
17.0cm



**RUBIN**  
18.0cm



**WALTER**  
19.0cm

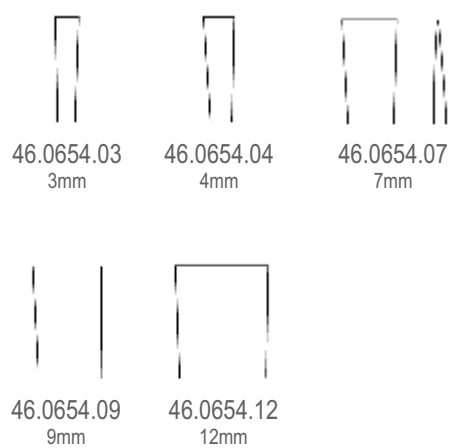

**WALTER**  
19.0cm

Nasal Rasps, Bone Files, Antrum Rasps  
 Knochenfeilen, Nasenraspeln, Antrumraspeln  
 Limas para huesos, escofinas nasales, escofinas para el antro  
 Рашпили  
 鼻锉，骨文件，鼻窦锉

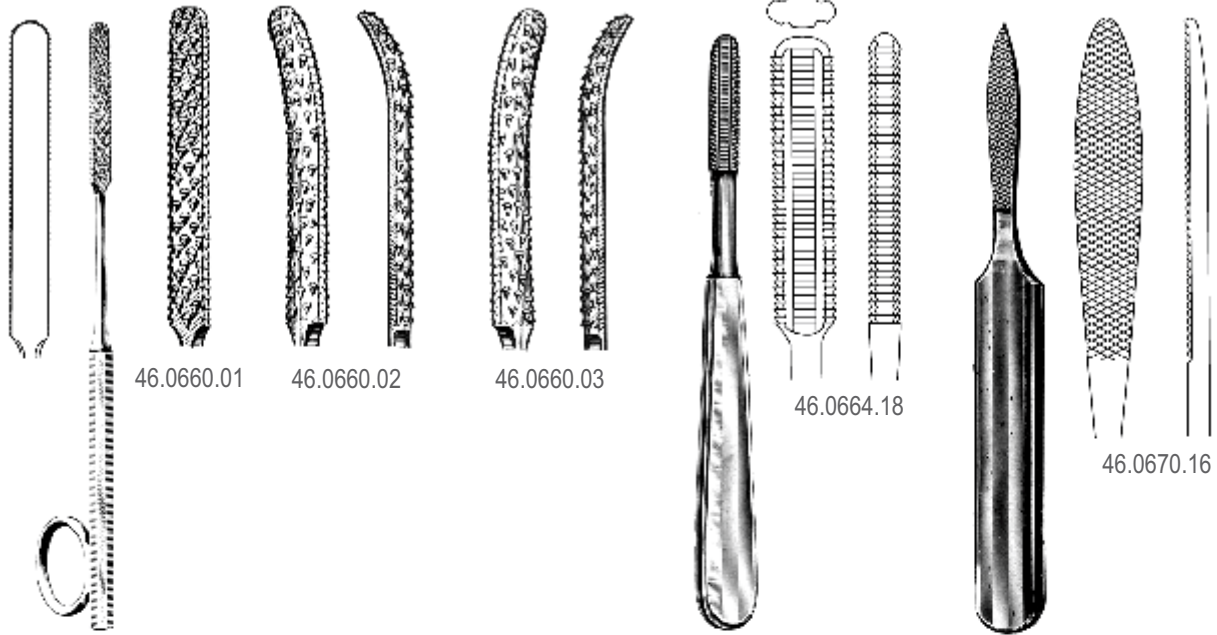

**GALLAHER**  
16.0cm

**MALTZ**  
18.0cm

**JOSEPH**  
16.0cm

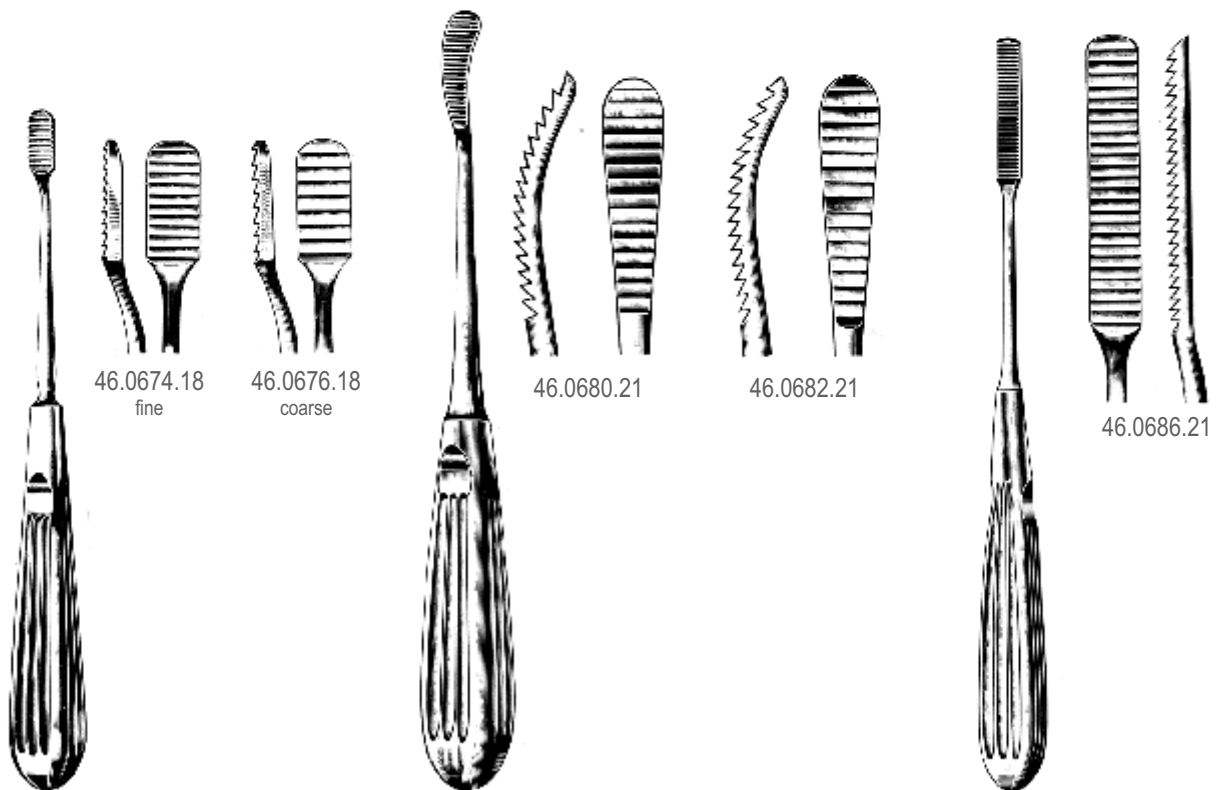

**LEWIS**  
18.0cm

**AUFRICHT**  
21.0cm

**COTTLE**  
21.0cm

RHINOLOGY



**WIENER**  
18.0cm



46.0690.18



46.0692.18

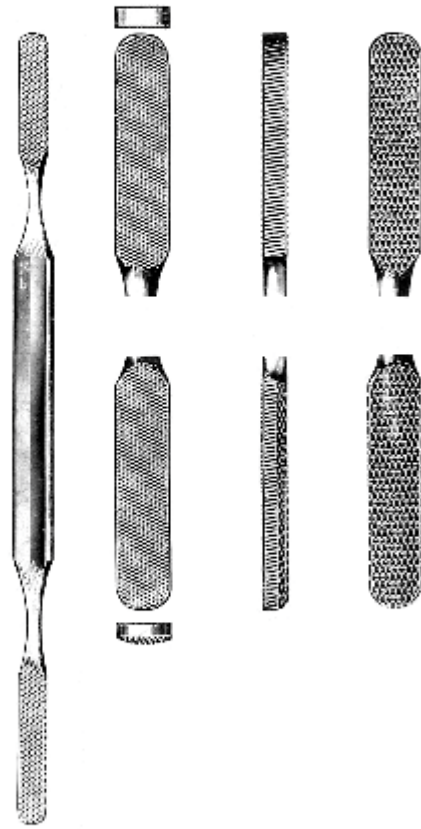

**FOMON**  
46.0696.21 21.0cm

Nasal Retractors, Nasal Hooks  
 Nasenhaken, Nasenhäkchen  
 Separadores nasales, ganchitos nasales  
 Ретракторы оториноларингологические  
 鼻腔拉钩, 鼻吊钩



**KILNER**  
 46.0700.10 10.0cm



**CONVERSE**  
 46.0704.12 12.0cm



**AUFRICT**  
 46.0710.16 16.0cm  
 46.0710.19 19.0cm

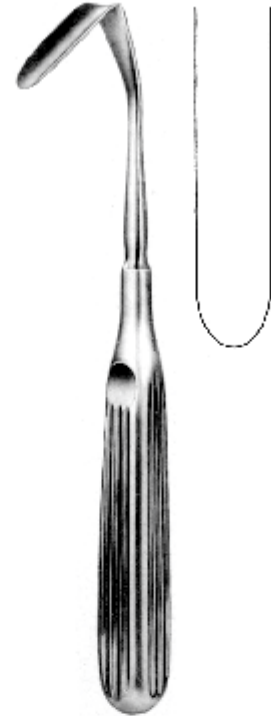

**AUFRICT**  
 46.0712.19 19.0cm



15.0cm

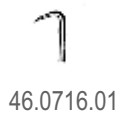

46.0716.01

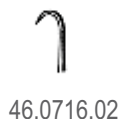

46.0716.02



46.0716.03



**LANGE**  
 46.0720.22 22.0cm



**FOMON**  
 46.0724.17 17.0cm



**COTTLE**  
 46.0730.16 16.0cm



**FREER**  
 46.0740.15 15.0cm

RHINOLOGY

Skin Grasping Forceps and Alar Hooks  
 Hautfasspinzetten und Nasenflügelhäkchen  
 Pinzas para piel y ganchitos para alas de nariz  
 Пинцеты захватывающие, Крючки  
 皮肤抓钳和阿拉尔挂钩

RHINOLOGY



**OGURA**  
46.0744.11 11.0cm



**COTTLE**  
46.0750.11 11.0cm



**COTTLE**  
46.0754.14 14.0cm



**COTTLE**  
15.0cm



46.0760.14



46.0762.01



46.0762.02

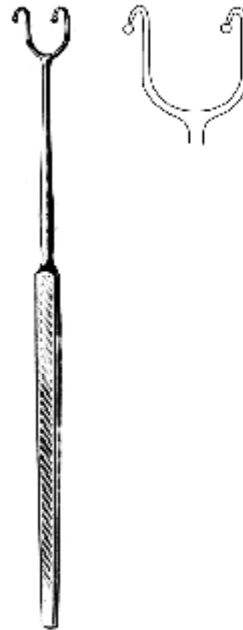

**FOMON**  
46.0766.16 16.0cm

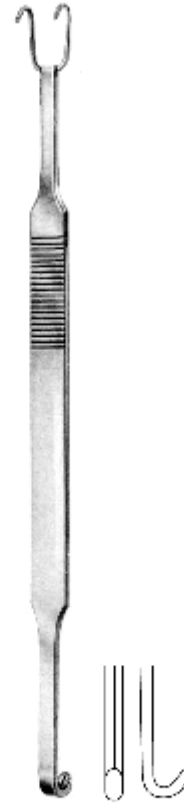

**COTTLE-NEIVERT**  
46.0770.20 20.0cm

Septum Suture Needles, Nasal Retractors  
 Septumnadeln, Nasenhaken  
 Aguja para sutura del tabique nasal, separadores nasales  
 Ретракторы оториноларингологические, Иглы  
 隔缝合针, 鼻拉钩



46.0774.01 46.0774.02 46.0774.03 46.0774.04 46.0774.05

46.0774.06 46.0774.07 46.0774.08 46.0774.09

**YANKAUER**  
17.0cm



**COTTLE**  
46.0780.14 14.0cm



**NEIVERT**  
46.0784.16 16.0cm



**COTTLE**  
46.0800.15 15.0cm



**COTTLE**  
46.0802.15 15.0cm



**AUFRICHT**  
46.0806.13 13.5cm

RHINOLOGY

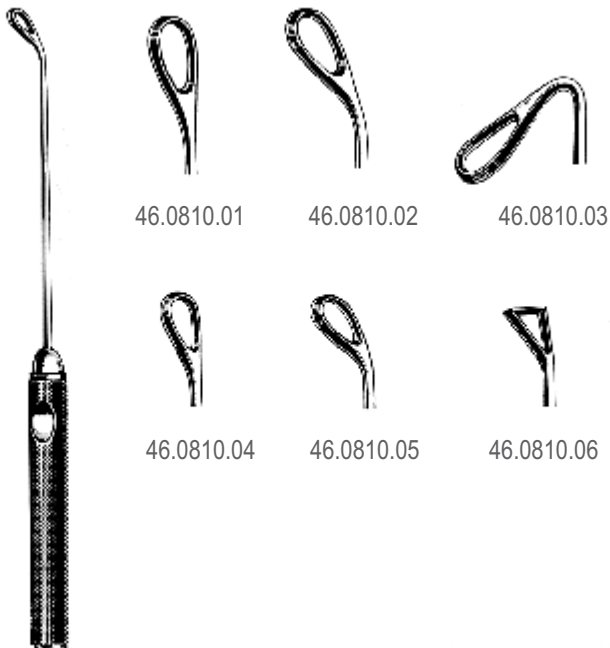

46.0810.01

46.0810.02

46.0810.03

46.0810.04

46.0810.05

46.0810.06

**COAKLEY**  
17.0cm



46.0814.01

46.0814.02

46.0814.03

46.0814.04

46.0814.05

**MYLES**  
17.0cm

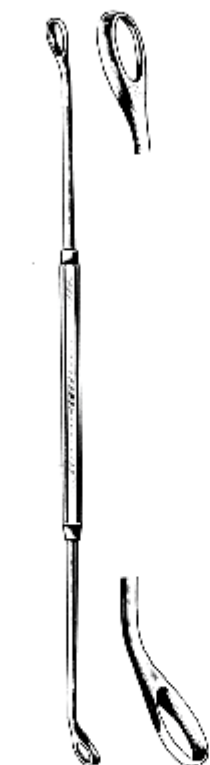

46.0820.20 20.0cm



**PRATT**  
46.0824.21 21.0cm

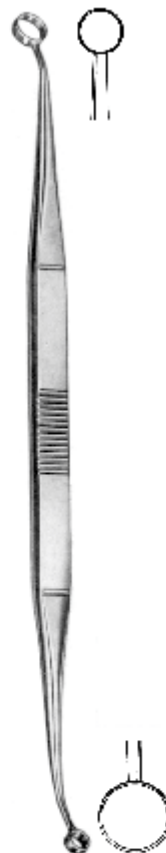

**FAULKNER**  
46.0826.21 21.0cm

Rhinoplastic Instruments etc.  
 Instrumente zur Nasanplastik usw.  
 Instrumentos para la plastica nasal etc.  
 Щипцы носовые  
 隆鼻仪器

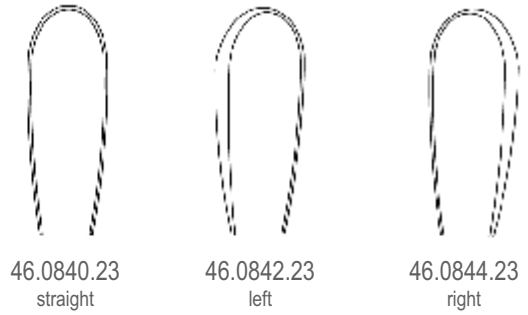

**KRESSNER**  
 46.0830.20 20.0cm

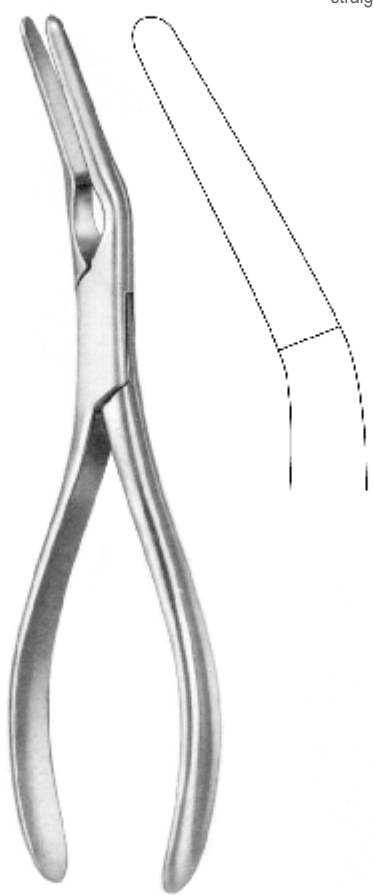

**ASCH**  
 46.0834.23 23.0cm



**COTTLE-WALSHAM**  
 23.0cm

RHINOLOGY

Adenoid Currettes  
Ringmesser  
Cuchillos para vegetaciones adenoides  
Кюретки аденоидные  
腺样体刮匙

RHINOLOGY



**BECKMANN** 22.0cm  
46.0850.01 - 46.0850.06



**BECKMANN** 22.0cm  
46.0852.01 - 46.0852.06



46.0850.01  
46.0852.01



46.0850.02  
46.0852.02



46.0850.03  
46.0852.03



46.0850.04  
46.0852.04



46.0850.05  
46.0852.05

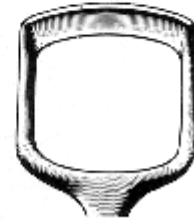

46.0850.06  
46.0852.06



**BECKMANN**  
22.0cm



46.0856.01



46.0856.02



46.0856.03



46.0856.04



46.0856.05



**ST. CLAIR-THOMSON**  
21.0cm



46.0860.08  
8mm



46.0860.10  
10mm



46.0860.12  
12mm



46.0860.14  
14mm



46.0860.16  
16mm



46.0860.18  
18mm

Antrum Retractor, Adentomes  
 Kierfer hohlenhaken, Tonsillotome  
 Separador para seno maxilar, Adenotomos  
 Аденоотомы  
 胃窦牵开



**BRUENINGS-BRUNK**  
 46.0864.21 21.5cm



**LA FORCE**  
 25.0cm

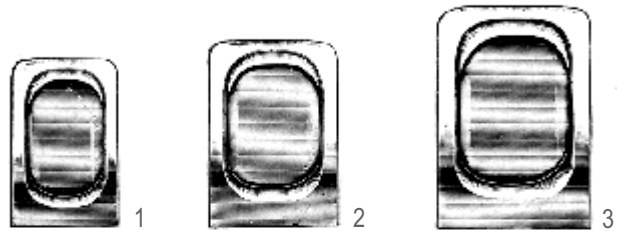

with unperforated blade  
 46.0870.01 Fig. 1  
 46.0870.02 Fig. 2  
 46.0870.03 Fig. 3

spare blades  
 46.0874.01 Fig. 1  
 46.0874.02 Fig. 2  
 46.0874.03 Fig. 3

with perforated blade  
 46.0872.01  
 46.0872.02  
 46.0872.03

46.0876.01  
 46.0876.02  
 46.0876.03

RHINOLOGY

