

THE ULTIMATE CHOICE

## **TONSIL**

Tonsil

Tonsil

Amigdala

ИНСТРУМЕНТЫ ДЛЯ МИНДАЛИН

扁桃體



Tonsil Needles  
Tonsillennadeln  
Agujas para suturas de amígdalas  
Иглы для миндалин  
扁桃體針

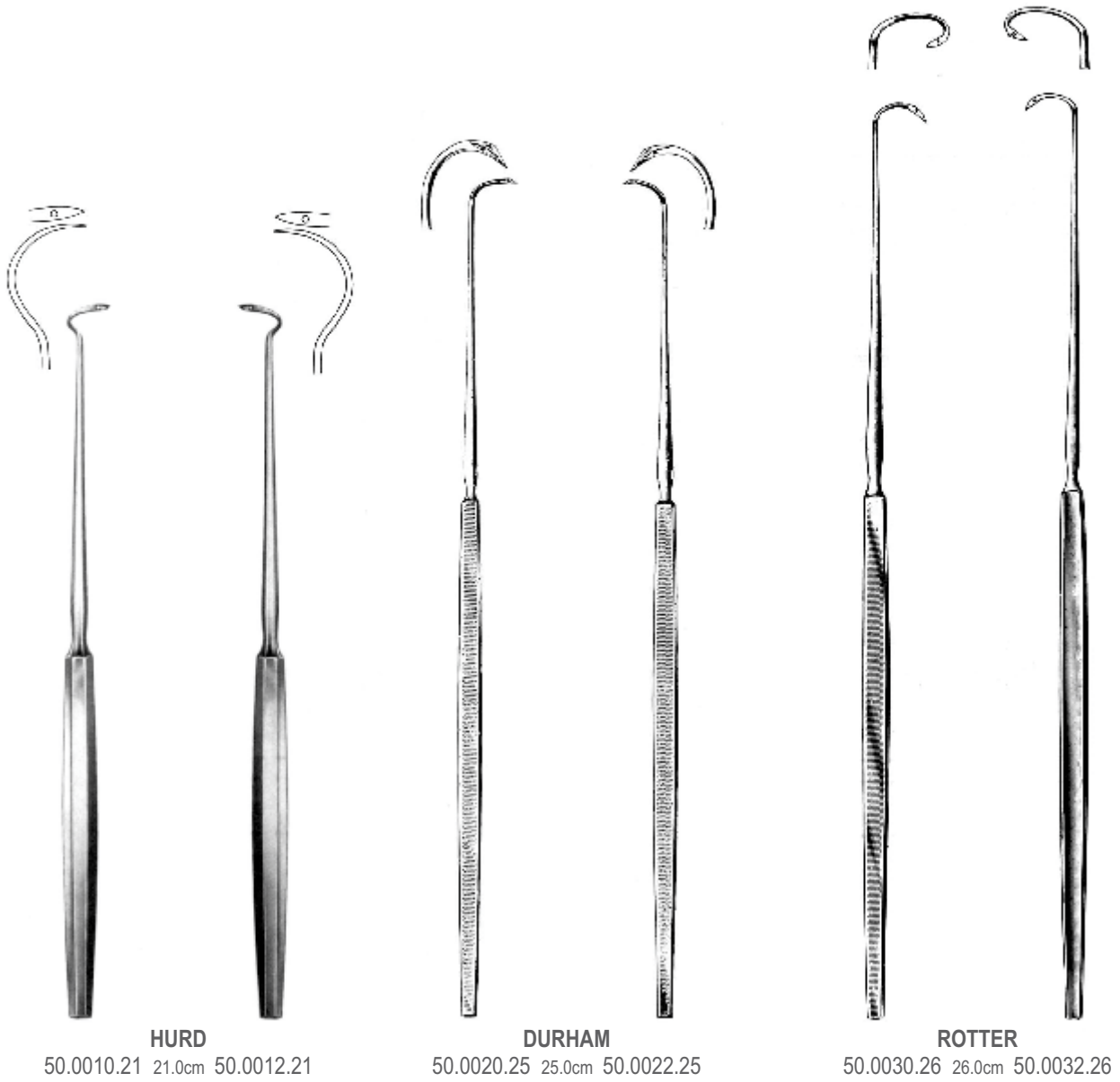

TONSIL

TONSIL



**NAGER**  
50.0040.24 24.0cm



**CLAUS-EICKEN**  
50.0046.23 23.0cm

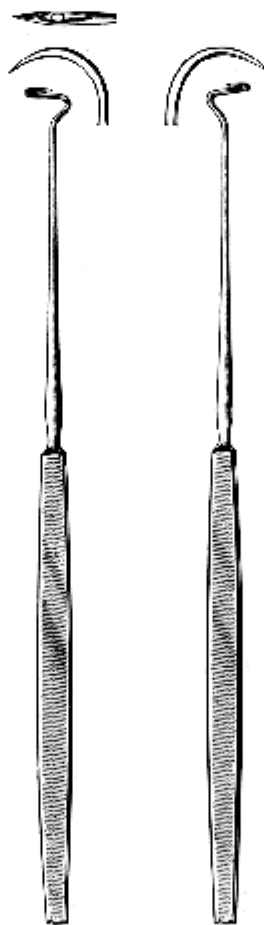

**DUPUY-WEISS**  
50.0050.22 22.0cm 50.0052.22



**FALK**  
50.0060.24 24.0cm 50.0062.24

Tonsil Knives  
Tonsillenmesser  
Bisturies  
Ножи для тонзилэктомии  
扁桃体刀



**BRUENINGS**  
50.0070.23 23.0cm



**ABRAHAM**  
50.0074.21 21.0cm



**FISHER**  
50.0080.22 22.5cm



**COLVER**  
50.0084.22 22.5cm

TONSIL

TONSIL



**DOUGLAS**  
50.0090.21 21.0cm



**CANFIELD**  
50.0094.21 21.0cm



**TYDING**  
50.0100.21 21.0cm



**LYNCH**  
50.0104.20 20.0cm



**DAY**  
50.0110.21 21.5cm



**LUNIATSCHEK**  
50.0114.19 19.0cm

Tonsil Knives, Dissectors, Enucleators, Retractor etc.  
 Tonsillenmesser, dissektoren, Enukleator, Retraktor usw.  
 Bisturies, disecadores, enucleador, separador etc.  
 Ретракторы оториноларингологические, Диссекторы  
 扁桃体拉钩及剥离子



TONSIL

**HURD**  
 50.0120.22 22.5cm

**HENKE**  
 50.0124.23 23.0cm

**HENKE**  
 50.0130.23 23.0cm

**CARPENTER**  
 50.0134.25 25.0cm

**CARPENTER**  
 50.0140.24 24.0cm

TONSIL



**LOVE**  
15.0cm  
50.0150.18 18mm  
50.0150.20 20mm  
50.0150.22 22mm



**MARSCHIK**  
50.0154.22 22.0cm

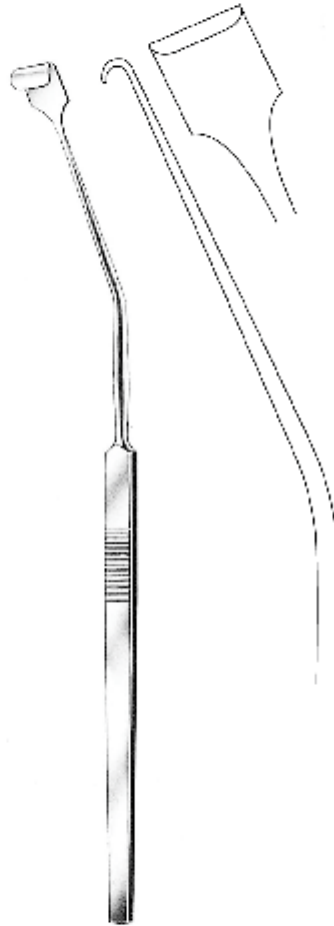

**NAGER**  
50.0160.24 24.0cm

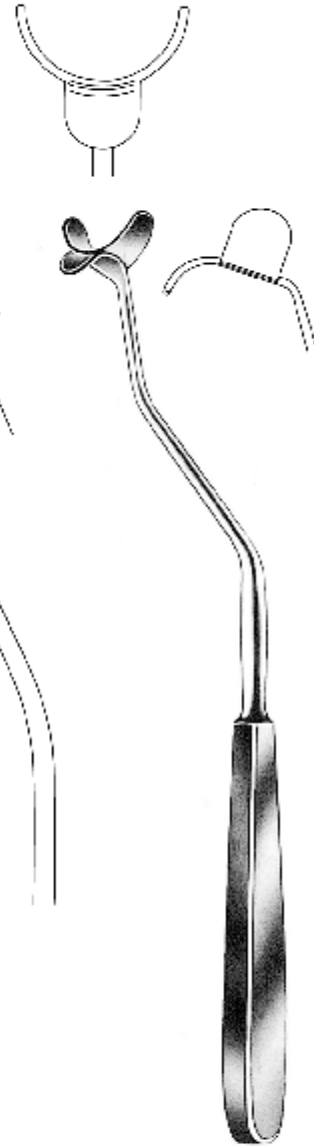

**HOFER**  
50.0164.24 24.0cm

Tonsil Seizing Forceps  
 Tonsillenzangen  
 Pinzas para coger las amígdalas  
 Щипцы для миндалин  
 扁桃體鉗

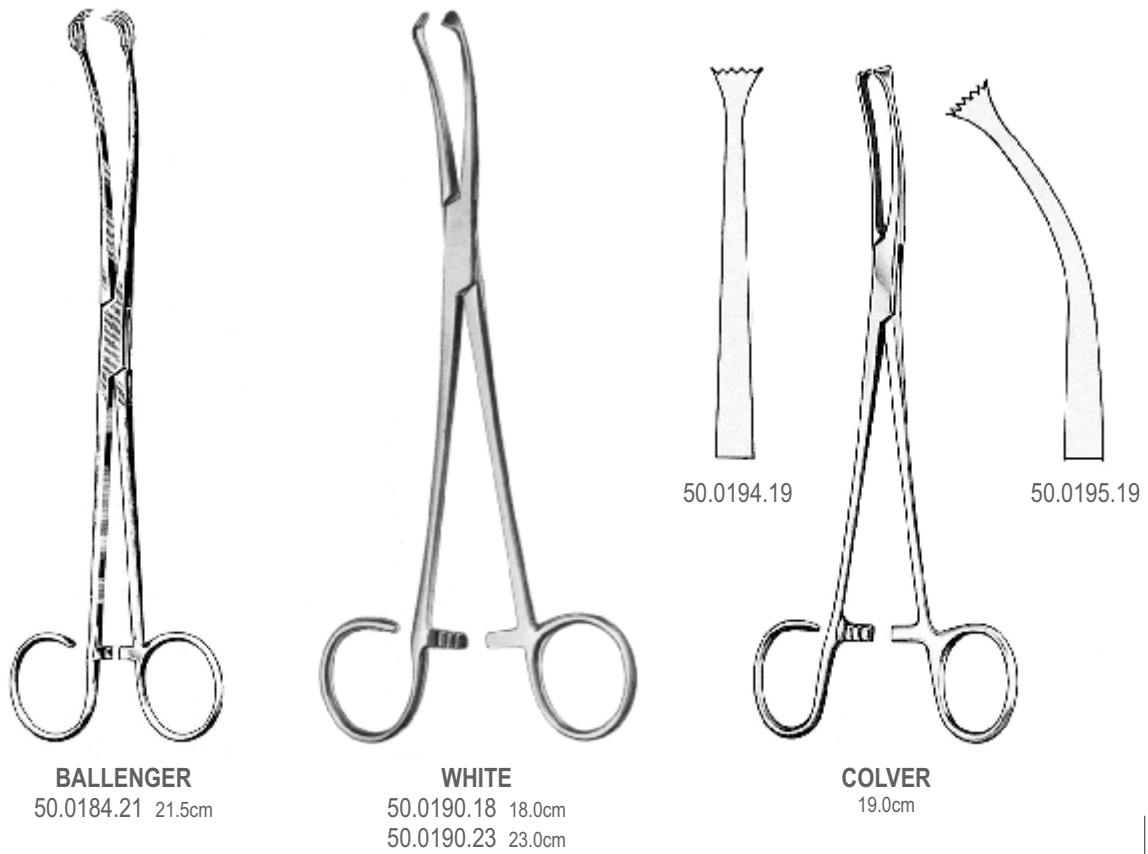
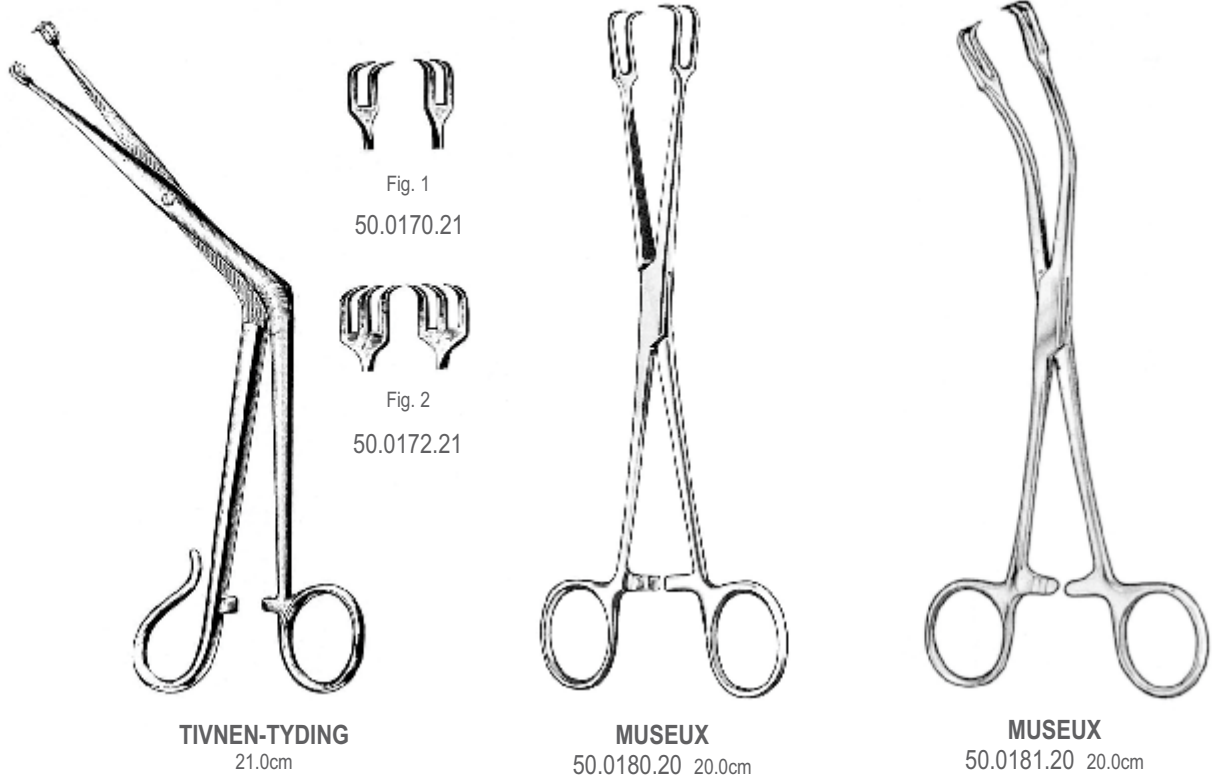

TONSIL

TONSIL

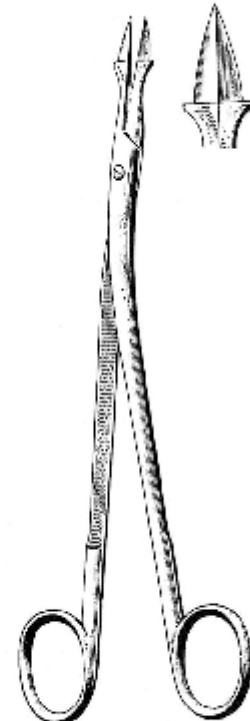
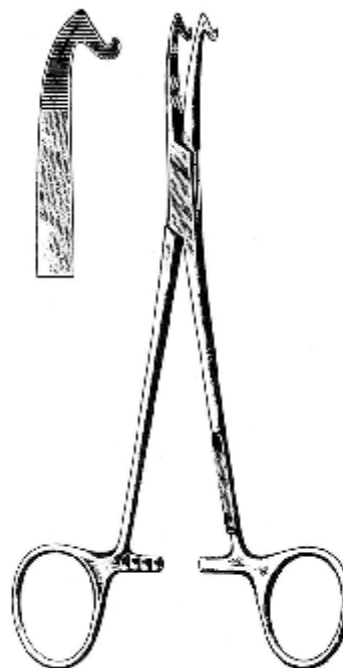
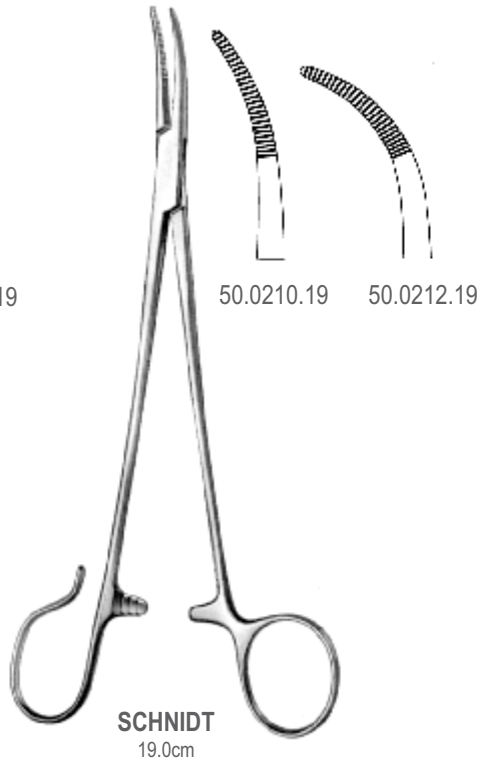
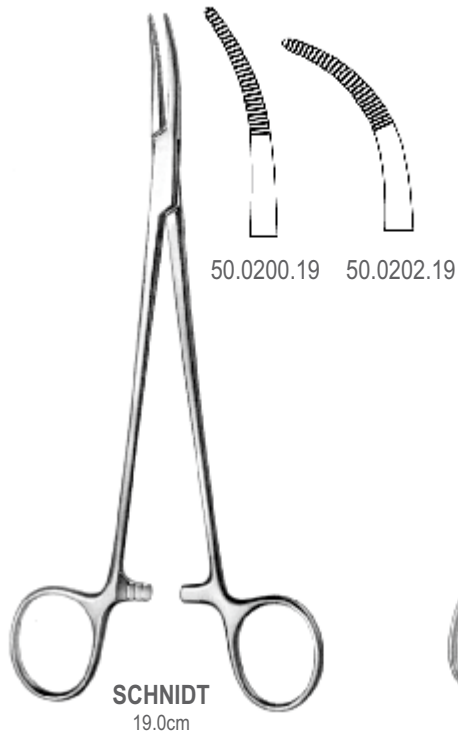

Tonsil Haemostatic Forceps  
 Tonsil Haemostatic zange  
 Pinzas de amigdala haemostatic  
 Щипцы для миндалин  
 扁桃体止血钳



**NEGUS**  
19.0cm



50.0230.19



50.0232.19

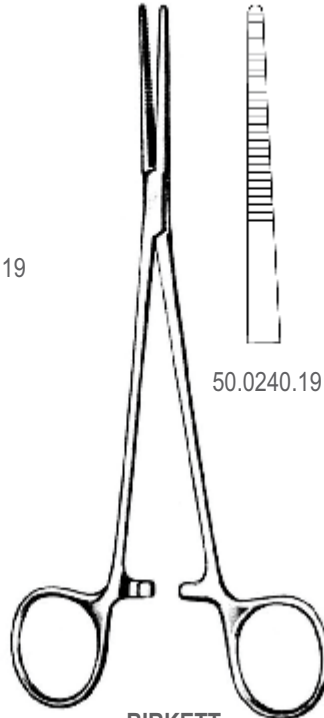

**BIRKETT**  
19.0cm



50.0240.19



50.0241.19



50.0243.19

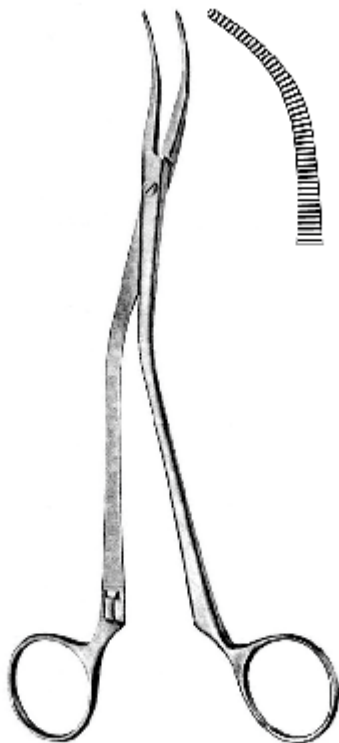

**WILSON**  
50.0250.19 19.0cm



**MOLLISON**  
50.0254.18 18.0cm (with horizontal opening)  
50.0256.18 18.0cm (with vertical opening)

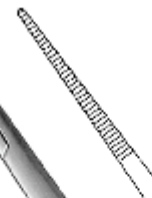

TONSIL

TONSIL



**EVES**  
50.0260.28 28.0cm



**EVES**  
50.0270.28 28.0cm



**BRUENINGS**  
50.0280.28 28.0cm

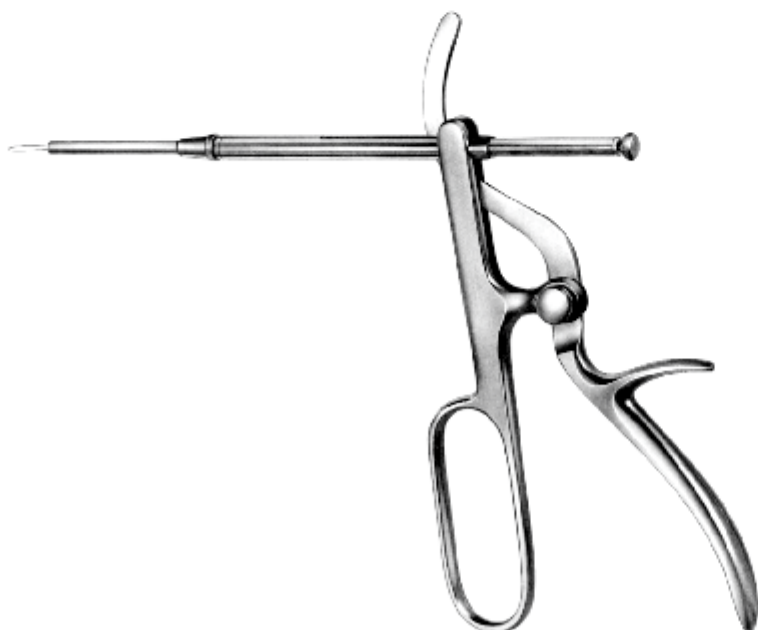

**TYDING**  
50.0290.00

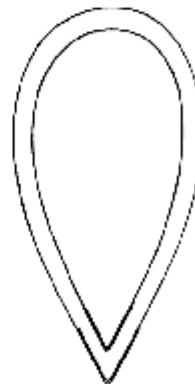

50.0300.40 40mm  
50.0300.50 50mm



50.0306.03 0.3mm Ø

Tonsillectomes  
Tonsillotome  
Amigdalotomos  
Тонзиллотомы  
扁桃体切除术

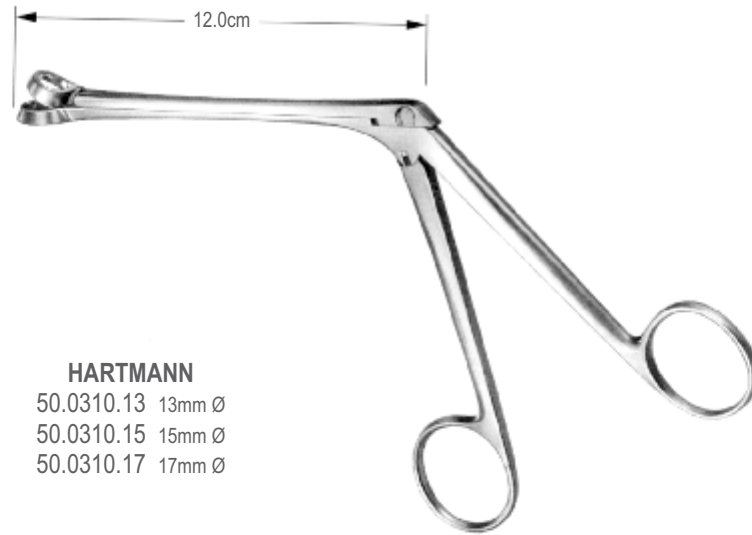

**HARTMANN**  
50.0310.13 13mm Ø  
50.0310.15 15mm Ø  
50.0310.17 17mm Ø

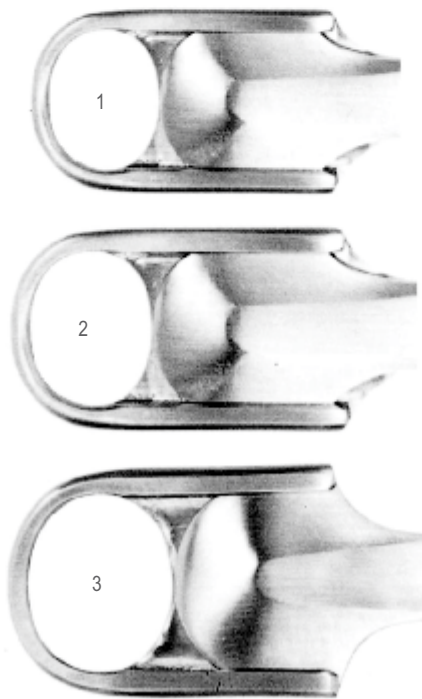

**SLUDER-BALLENGER**  
50.0320.00 compl.  
3-tips  
50.0320.01  
50.0320.02  
50.0320.03

TONSIL

Universal Handles and Interchangeable Tubes, Broncho-Esophagoscopy Forceps  
 Universalgriffe und Veriangerungsröhre, Broncho-Oesophagoskopiezangen  
 Mangos universales y tubos de extension, pinzas para bronco-esofagoscopia  
 Щипцы биопсийные  
 通用手柄和可更换管，支气管，食管镜钳

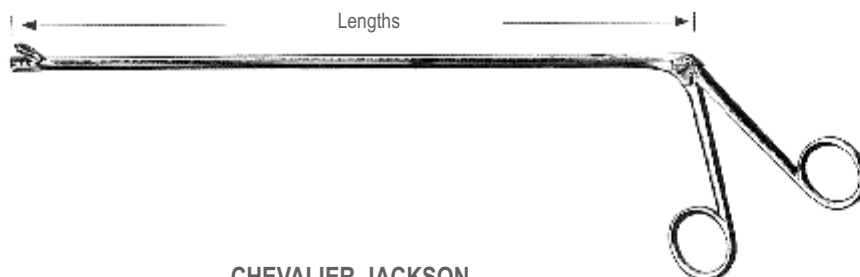

**CHEVALIER-JACKSON**



30.0cm	50.0331.30	50.0332.30	50.0333.30	50.0334.30	50.0335.30	50.0336.30	50.0337.30
40.0cm	50.0331.40	50.0332.40	50.0333.40	50.0334.40	50.0335.40	50.0336.40	50.0337.40
50.0cm	50.0331.50	50.0332.50	50.0333.50	50.0334.50	50.0335.50	50.0336.50	50.0337.50
60.0cm	50.0331.60	50.0332.60	50.0333.60	50.0334.60	50.0335.60	50.0336.60	50.0337.60

TONSIL



**HUBER**  
50.0340.00



**BRUENINGS (straight)**  
 50.0344.20 20.0cm  
 50.0344.30 30.0cm  
 50.0344.40 40.0cm  
 50.0344.50 50.0cm  
 50.0344.60 60.0cm

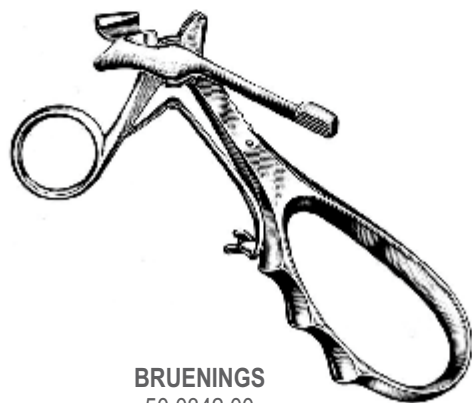

**BRUENINGS**  
50.0342.00



**BRUENINGS**  
50.0346.20 20.0cm

Cutting and Grasping Forceps Tips  
 Auswechselbare Zangenaufsätze  
 Pinzas intercambiables  
 Щипцы биопсийные  
 切割和抓钳提示



**FRAENKEL**  
50.0350.00



**BARACANI**  
50.0354.00



**SEIFFERT**  
50.0360.00



**FRAENKEL**  
50.0364.00



**BRUENINGS**  
50.0370.01  
50.0370.02



**BRUENINGS**  
50.0374.01  
50.0374.02



**LANGE**  
50.0380.00



**KRAUSE**  
50.0384.01  
50.0384.02



**SCHUMACHER**  
50.0390.00



**CORDES**  
50.0394.01  
50.0394.02



**CORDES**  
50.0400.00



**ROSENBERG**  
50.0404.00



**KRAUSE**  
50.0410.00

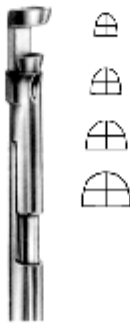

**CORDES**  
50.0414.01  
50.0414.02  
50.0414.03  
50.0414.04



**SCHEINMANN**  
50.0420.00



**SCHEINMANN**  
50.0424.00

TONSIL



50.0430.11



50.0434.10

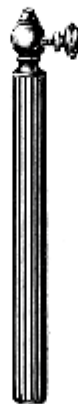

50.0440.11



50.0444.12



50.0450.00

TONSIL



**MICHEL**  
25.0cm



50.0460.12



50.0460.14



50.0460.16



50.0460.18



50.0464.08  
50.0464.10  
50.0464.12  
50.0464.14  
50.0464.16  
50.0464.18  
50.0464.20  
50.0464.22  
50.0464.24  
50.0464.26  
50.0464.28  
50.0464.30

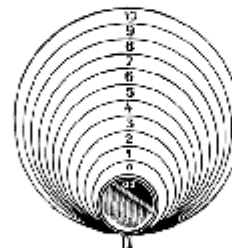

fig.00, 8mm Ø  
fig.0, 10mm Ø  
fig.1, 12mm Ø  
fig.2, 14mm Ø  
fig.3, 16mm Ø  
fig.4, 18mm Ø  
fig.5, 20mm Ø  
fig.6, 22mm Ø  
fig.7, 24mm Ø  
fig.8, 26mm Ø  
fig.9, 28mm Ø  
fig.10, 30mm Ø



50.0466.08  
50.0466.10  
50.0466.12  
50.0466.14  
50.0466.16  
50.0466.18  
50.0466.20  
50.0466.22  
50.0466.24  
50.0466.26  
50.0466.28  
50.0466.30

Laryngeal Polypus Forceps, Epiglottis Retractor, Tampon Forceps  
 Kehlkopfpolypenzangen, Deckelhalter, Tamponpinzetten  
 Pinzas para polipos laringeos, depresor para epiglottis, pinzas para toponamientos  
 Щипцы полипные, Пинцеты, Ретракторы  
 喉息肉钳，会厌牵开，凹凸钳



50.0470.01



50.0470.02



50.0470.03

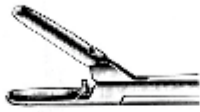

50.0470.04

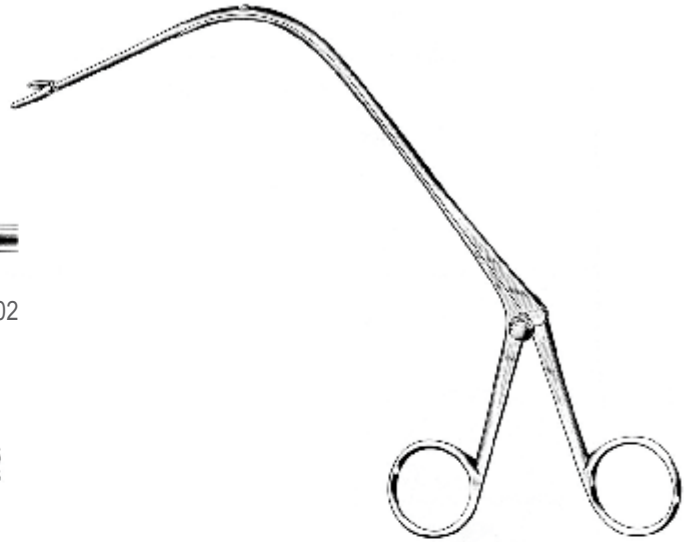

**JURASZ**  
23.0cm

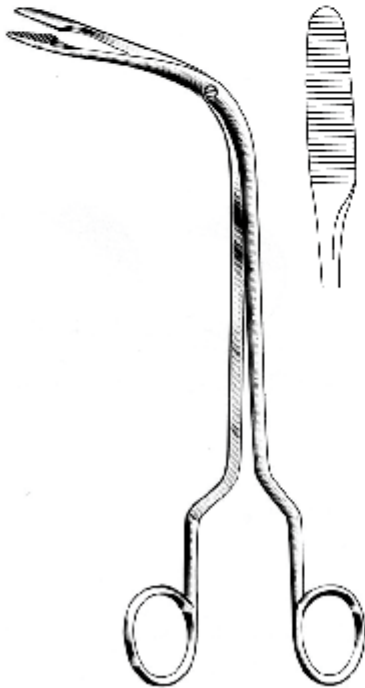

**FRAENKEL**  
50.0474.19 19.0cm

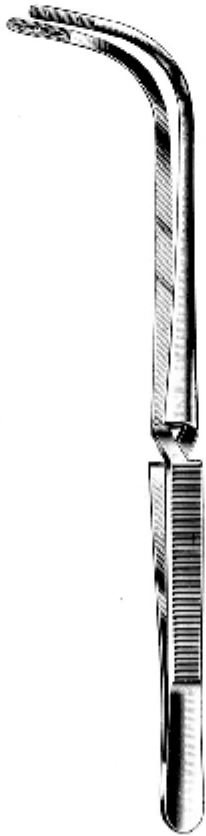

**JACKSON**  
22.0cm



50.0480.22



50.0482.22



**REICHERT**  
50.0486.24 24.0cm

TONSIL